

Spare Parts Catalogue Systems

Version 1.0 • 27 June 2019



German Headquarters:

Scienta Omicron GmbH

Limburger Str. 75

65232 Taunusstein, Germany

Tel.: +49(0) 61 28 / 987-0

E-Mail: services@scientaomicron.com

scientaomicron

Preface

Foreword

This document is intended to provide at a glance information on the most commonly used spare parts and consumables for Scienta Omicron UHV Systems and their frequently used components. The catalogue does not offer a complete list of everything that is available. The customer is encouraged to contact Scienta Omicron Services whenever looking for an item not listed in the catalogue.

The current version of the catalogue does not include any information on spares and consumables for SPM heads and their equipment, system controllers, sample stages (with exception of manipulator sample stages) and a major part of sources and detectors. These are planned to be added in future versions.

For some older components, only limited support is offered and they are thus excluded from the catalogue. Examples are SEM100/250/500, EKF300/1000, SL1000, FXS, NGI3000, CMA100/150.

Consumables vs spares

Scienta Omicron distinguishes between consumables and spare parts. Consumables are all parts that are subject to usual wear and need to be replaced after a certain operation time, even if no fault occurred and well treated. They are discarded after replacement and not repaired and are not subject to warranty. *Consumables* are marked throughout this document in color and italic, e.g. *PN04404-S*. Typical consumables include filaments, gaskets, and crucibles.

Exchanges

For some spare parts Scienta Omicron offers a special exchange program: We offer a refurbished part from stock which is purchased for the price of a new part. If the defective part is returned by the customer within 6 months of the order confirmation, we will issue credit for the return. If there is little time delay between the two, only one bill is created for this process. An exchange is always subject to availability of a refurbished part and needs to be ordered in advance.

Repairs and estimates

Whenever an item needs to be sent back for repair, Scienta Omicron will either charge a flat repair fee or an estimate. The estimate is a fixed price that covers handling and inspection of the device. Once the actual repair costs are defined, and if they exceed the estimate price, the actual costs are quoted to the customer as repair costs. The estimate price will be credited to this costs. The customer needs to order the repair separately or decide to abort the repair. Only after the second order, the repair will proceed.

Returns

Any return, whether for repair or exchange, needs to be announced to Scienta Omicron. A set of return papers will be issued with further instructions and the item has to be sent back within 4 months. Please note that Scienta Omicron will not accept any returned items without a proper set of

return papers. These papers include a decontamination sheet through which the customer verifies that the item is free from harmful substances. For any item that was mounted at any time to the vacuum side of a customer's UHV system, it is mandatory that the decontamination sheet be filled out and signed. Scienta Omicron reserves the right to refuse the handling of any item contaminated by harmful substances.

Disclaimer

All information given in this document is subject to change without notice. This document has been compiled carefully but mistakes cannot be excluded. No guarantee can therefore be given for the accuracy of the information contained in this document.

Contents

Preface	1
Lighting and Cameras	5
Chamber light	5
Cameras and monitors	5
Sample transfer	7
Wobble sticks	7
Wobble sticks with Bellows	7
Magnetically coupled wobble sticks	8
Linear transfer	9
Sample loading and storage	11
Wafer transfer	13
Sample plates and wafer holder for 2" MBE Systems	13
Wafer Holder for 4" MBE Systems	15
UHV parts	18
CF parts	18
Valves	20
Gate valves	20
Right angle valves	22
Gas inlet valves	23
Pressure measurement	25
Ion gauge	25
Pirani gauge	26
Pumps	27
Ion Getter Pumps	27
Titanium Sublimation Pumps	27
Scroll pumps	28
Bake-out	29
System accessories	31
Manipulator Sample Stages	32
Resistive tungsten wire sample heater	32
Resistive PBN sample heater	32
Spare parts for resistive PBN sample heaters	33
Spare parts for Resistive PBN sample heater for secondary rotation:	37
E-beam sample heater	38
Spare parts for E-Beam sample heaters	38
High temperature sample heater (1670 K)	40
Spare parts for high temperature sample heaters	41
High Temperature Sample Heater (2500 K)	41
Manipulator electrical connections	42
In-vacuum wiring	42
Ceramics for manipulator wiring	42
Standard Feedthroughs and Cables	43
Power Supplies for Manipulator heaters	47
Liquid nitrogen cooling	47

Evaporators	49
EFM Evaporators	49
Standard crucibles	49
Barrel connectors for crucibles.....	51
Spare ceramics for EFM	51
Water cooling spare parts for EFM	52
Filaments for EFM.....	52
Effusion Cells	53
Overview	53
Spare parts and crucibles	53
MBE Accessories	57
Shutter Module for effusion cell.....	57
BFM – Beam Flux Monitor	57
QMB – Film Thickness Monitor	57
Cooling-water distributor	57
Ion sources	59
ISE 5	59
ISE 10 and ISE 100.....	60
IS 40 Ion Source	61
FIG05.....	61
FDG 15 and FDG 150	61
GCIB	62
IONEC IG70	62
Canyon Focused Ion Beam.....	62
Electron sources and Scanning Electron Microscopes.....	63
UHV Gemini	63
Vortex.....	63
Vortex UHV SEM column.....	63
Channeltron-SED for LT Nanoprobe with Vortex column.....	63
Standard SEM calibration samples	64
Sample Neutralization	65
FS40A1 Flood Source.....	65
CN10 Charge Neutralizer.....	65
UV/Vis Sources	66
Hg UV Source	66
HIS13/HIS14 VUV Source.....	66
X-Ray sources.....	68
HAXPES Metaljet D2+	68
Electron diffraction.....	71
SpectaLEED, LEED/Auger, MCPLEED, SPALLEED	71
IntegralLEED.....	72
Analysers and Detectors	73
PEEM	73
PEEM sample plates.....	73
SPLEED for SEMPA	73

Lighting and Cameras

Chamber light

PN05555-S *LED Chamber light clip*



Power Supply Voltage	12V DC
Beam Angle	60°
Power Consumption	1.5W
Color Temperature	5700K
Cable Connection	Power Jack 5.5 x 2.1
Max Ambient Temperature	45°C
Lifetime	50.000 h

Vacuum chamber LED light is an advanced light source designed to illuminate UHV systems and can be clamped onto flange nuts or bolts. The clip is compatible with M8 and M6 nuts and is stable in any orientation on UHV-viewports. Due to LED technology it is efficient and has a very long lifetime.

PN04467-S *Module power supply*

Power supply package for LED chamber lights, cameras and monitors.

The module contains:

- power cable
- 12V power supply
- Low voltage junction for 6 DC plugs.

Cameras and monitors

PN06819-S *Chamber scope*

Standard color camera for observation of tip approach and sample handling. The analog CMOS camera provides a wide dynamic range and has 1080P full HD resolution via BNC cable. To be used together with **PN04469-S Module camera accessories**, **PN04467-S Module power supply** and **PN04471-S Module monitor**

PN04469-S *Module camera accessories*

Accessories for video camera PN06819-S.

The module contains:

- Zoom lens and 2x extender
- Ball joint for flexible mount
- Mounting bracket for UHV chamber
- Power cable 2m (fits to PN04467-S power supply module)

PN04471-S *Module monitor*

Small bench-top monitor for camera-assisted transfer or tip approach.

Monitor technical data

Display	8" TFT LCD color
Resolution	1024x768
Input options	HDMI/ CVBS/ BNC/ AV/ VGA

The module contains:

- Video monitor with stand
- Power cable 3m (fits to PN04467-S power supply module)
- BNC video cable 3m (fits to PN06819-S video camera)

Sample transfer

Wobble sticks

Wobble sticks with Bellows

Some of our wobble sticks with bellows are available as exchange items at a flat fee: you will receive a refurbished wobble stick and can return your defective wobble stick for partial credit within 4 months. The return shipment must be accompanied with a valid declaration of decontamination in which you guarantee that the item is free from harmful substances. Before ordering, please inquire about the availability of refurbished items.

Please use the pictures and tables below to identify the correct wobble stick type.

Wobble sticks with orthogonal pincer grip

These are wobble sticks equipped with a fixed 90° pincer grip. The distances are measured from the sealing side of the mounting flange in the fully retracted position ("pull").

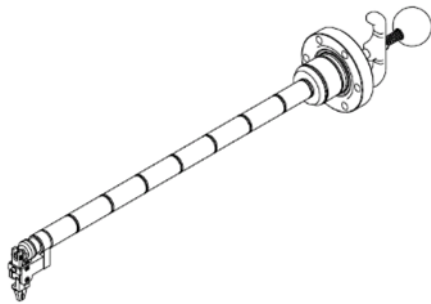

	E2291-S	E2287-S	E2288-S
	WS 120	WS 180	WS 270
In vacuum	134 mm	177 mm	229 mm
Ex vacuum	227 mm	287 mm	377 mm
Total length	361 mm	464 mm	606 mm
Travel	120 mm	180 mm	270 mm

Wobble sticks with in-line pincer grip

These are wobble sticks equipped with a removable straight pincer grip. The distances measure from the sealing side of the mounting flange in the fully retracted position ("pull").

	E2294-S	E2296-S	E2295-S	PN04177-S	E2297-S
	WS 67 IL	WS 120 IL	WS 180 IL	WS 180 IL (body only)	WS 270 IL
In vacuum	152 mm	182 mm	225 mm	183 mm	277 mm
Ex vacuum	174 mm	227 mm	287 mm	287 mm	377 mm
Total length	326 mm	409 mm	512 mm	470 mm	654 mm
Travel	67 mm	120 mm	180 mm	180 mm	270 mm

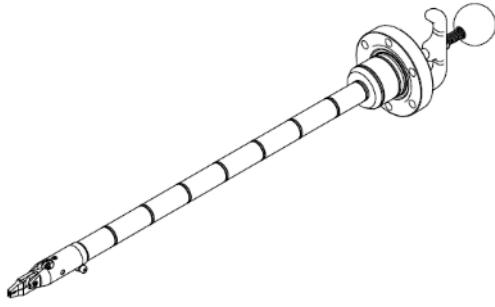

E2182-S **Inline jaw assembly**

In-line pincer grip for WS XXX IL bodies.

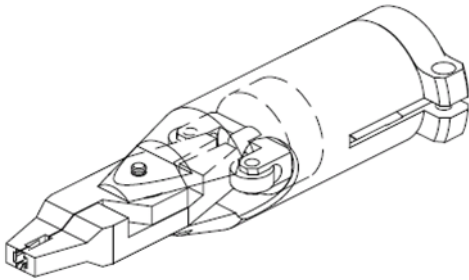

S103903-S **Rest for wobble stick with bellows**

This support rod prevents the wobble stick from being pulled into the system and provides fixing in a neutral position.

Length	Part number	Commonly used with
120 mm	S103903-S	Orthogonal WS180
155 mm	R200572-S	Inline wobble sticks
190 mm	R209499-S	Orthogonal WS 270



Magnetically coupled wobble sticks

As an alternative to wobble sticks with bellows, magnetically coupled wobble sticks are available with standard Scienta Omicron in-line and orthogonal pincer grips. They are less likely to develop vacuum leaks, but have a fixed shaft that always protrudes from the UHV system. When replacing a wobble stick with bellows, please consider requirements for minimal retraction length, travel range and maximum angle as well as bake-out tent restraints. Please contact Scienta Omicron Services to assist you in identification of the best replacement option.

For standard LT STM systems, the following wobble sticks are recommended:

Adapter flange type	Transfer positions	Wobble stick with bellows	Magnetically coupled wobble stick
AF180 (Gen. II)	STM and room temperature storage carousel only	WS180 IL E2295-S	PN05025
AF 270 (Gen. II)	Tip Preparation Tool, LN ₂ cooled storage carousel, heater stage, sample cleaving	WS270 IL E2297-S	R209924
AF180 (Gen. III)	STM and room temperature storage carousel only	WS180 IL E2295-S	R217920
AF180 (Gen. III)	Tip Preparation Tool, cooled storage carousel, heater stage, sample cleaving	n/a	R219681

Please note: Some options, like the LHE cold storage position, require the full rotation of a magnetically coupled wobble stick.

The pincer grip **E2182-S** is not included. All wobble sticks are without support. When switching to a magnetically coupled wobble stick, modification of bake-out tent might be required.

Rest for magnetically coupled wobble sticks

This rest is suitable for certain magnetically coupled dual shaft wobble sticks. The length of the support depends on the model of your wobble stick. When ordering please indicate the amount of linear travel of your wobble stick.

PN01035-S

Straddled flange/ 3 rods (Standard)

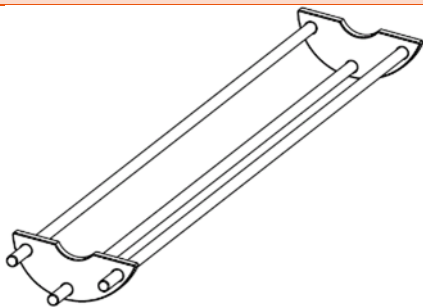

PN01993-S

Inline flange/ 4 rods

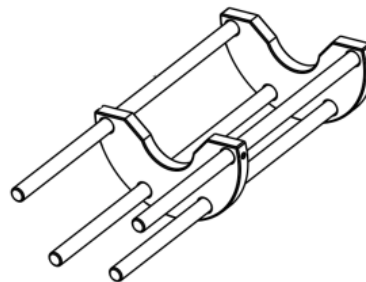

Linear transfer

High power probes for vertical transfer

Magnetically coupled transfer rods for rotation and translation. The magnet is bakeable up to 250°C.

Specifications:

- 360° continuous rotation
- Torque 1 Nm

- Axial Thrust 50 N
- Maximum bakeout temperature (including external magnet): 250°C
- Standard linear position lock



Part number	Description	Flange size	Travel range
F2039-S	Magnetic probe 12"	DN40CF	305 mm
F2094-S	Magnetic probe 18"	DN40CF	460 mm
F2095-S	Magnetic probe 24"	DN40CF	610 mm
F2096-S	Magnetic probe 36"	DN40CF	914 mm
CA06423-S	Magnetic probe 36"	DN63CF	914 mm

Other lengths are available on request.

Models with a DN40CF flange have an internal probe diameter of 19.0 mm. Models with a DN63CF flange have an internal probe diameter of 25.4 mm.

PN01887-S *Transfer head (standard)*

Transfer head with open/close mechanism for standard Scienta Omicron sample plates, to be mounted on a 19.1 mm shaft.



S1106-S *Hard metal rod for transfer head*

Spare metal rod for transfer head **PN01887-S**.



E2155-S Adapter for transfer head

Adapter for magnetic probe shaft from 3/4" (12.7 mm) to 1" (19.1 mm).

Sample loading and storage

B001327-S Sample loading stage for FEL

To be mounted on a 19.1 mm shaft, including adapter for 12.7 mm shafts.

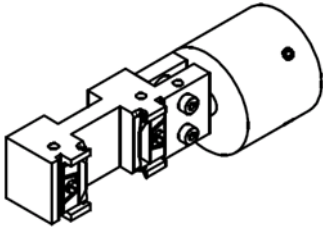

R210972 Triple sample loading stage for FEL

To be mounted on a 19.1 mm shaft.

Lengths from shaft:

- Middle position 1 – 28 mm
- Middle position 2 – 59 mm
- Middle position 3 – 90 mm
- End of stage – 106.5 mm

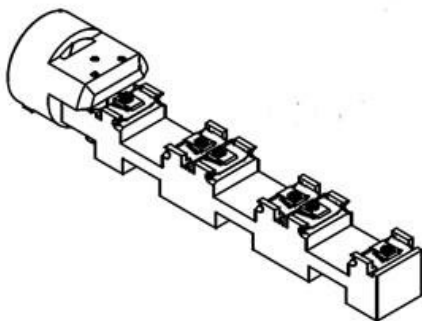

R208100-S Horizontal sample storage stage

To be mounted on a 19.1 mm shaft.

Provides space for three samples. This unit can be extended with additional modules **CA00946-S**. Also available with shaft connector on opposite side (**R207688**).

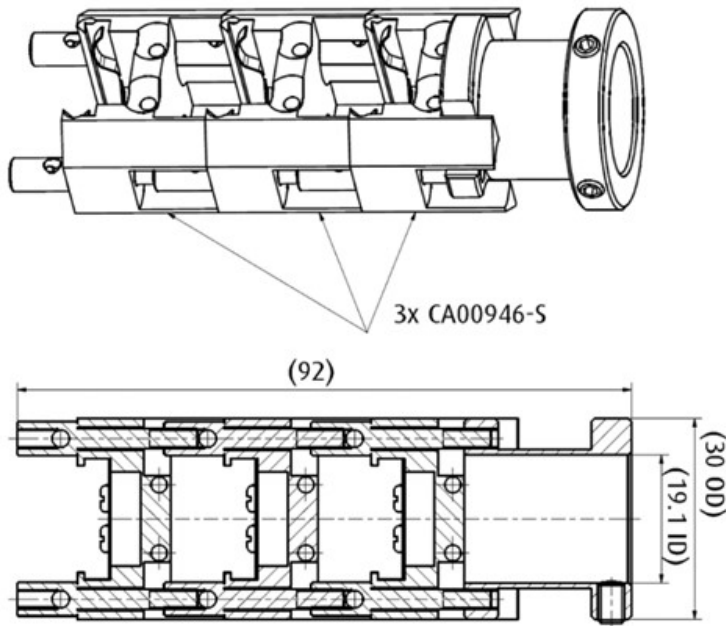

CA00946-S *Additional sample module for horizontal sample storage stage*

Can be used to extend the linear storage facility R208100-S or R207688-S. Extends total length by 22 mm.

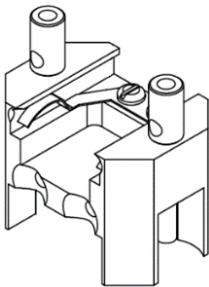

R1691-S *Load lock loading tool*

This tool is used to transfer samples onto the transfer head in the fast entry lock.



Wafer transfer

Sample plates and wafer holder for 2" MBE Systems

R205135-S **Sample plate 2" (molybdenum, 1 mm)**

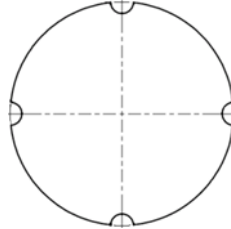

Outer diameter: 62 mm. Total thickness: 1 mm. Material: molybdenum.

R205825-S **Sample plate 2" (molybdenum, 2 mm)**

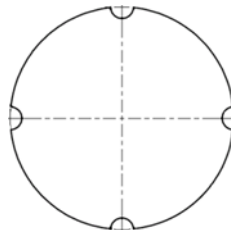

Outer diameter: 62 mm. Total thickness: 2 mm. Material: molybdenum.

R209620-S **Sample plate 2" with window and threads (molybdenum)**

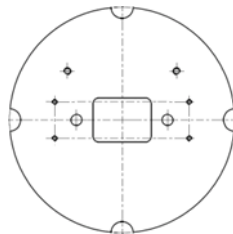

(No rim for wafer seating)

Outer diameter: 62 mm. Window size: 16x12 mm² (rounded corners). Total thickness: 2 mm. Material: molybdenum. Equipped with 2x M2 and 4x M1.4 threads, as well as 2x 3 mm through holes.

R213485-S **Sample plate 2" with window and threads (molybdenum)**

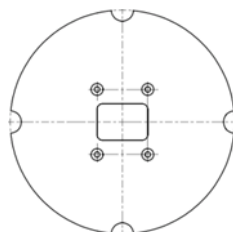

(No rim for wafer seating)

Outer diameter: 62 mm. Window size: 14x10 mm² (rounded corners). Total thickness: 1 mm. Material: molybdenum. Equipped with 4 index holes (spacing: 14x18 mm).

PN01842-S **Wafer holder for 2" wafers (molybdenum)**

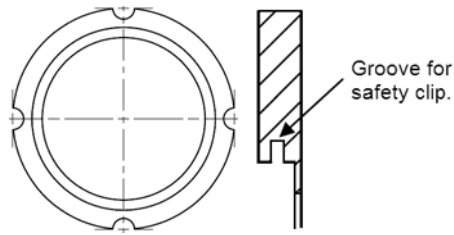

Outer diameter: 62 mm. Inner diameter: 45.6 mm. Wafer size: 51.3 mm (2"). Total thickness: 2 mm. Substrate thickness: up to 0.5 mm with safety clip, or up to 1.7 mm without safety clip. Material: molybdenum.

R206291-S Wafer holder for 2" wafers (molybdenum)

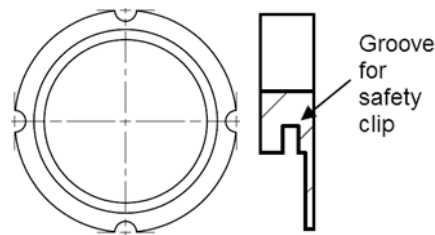

Outer diameter: 62 mm. Inner diameter: 45.6 mm. Wafer size: 51.3 mm (2"). Total thickness: 2 mm. Substrate thickness: up to 0.28 mm with safety clip, or up to 1.7 mm without safety clip. Material: molybdenum.

R212787-S Wafer holder for 2" wafers (molybdenum)

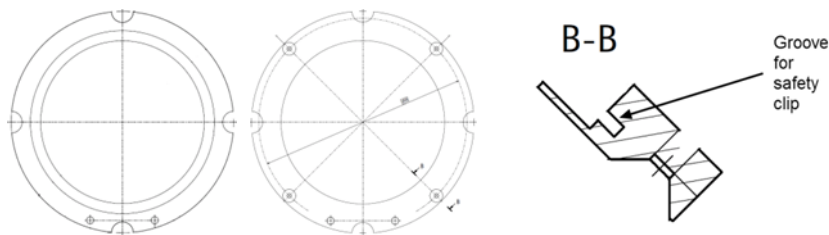

With index 2x pins and 4x index holes on the back side.

Outer diameter: 62 mm. Inner diameter: 45.6 mm. Wafer size: 51.3 mm (2"). Total thickness: 3 mm. Substrate thickness: up to 0.5 mm with safety clip, or up to 2.7 mm without safety clip. Material: molybdenum.

PN01843-S Wafer retaining spring for 2"



Can be used as a safety clip for wafer holders with groove.

R215574-S Circlip for 2" wafer

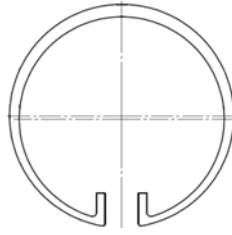

Can be used as a safety clip for wafer holders with groove.

Wafer Holder for 4" MBE Systems

R212833-S *Wafer holder for 4" wafers (molybdenum)*

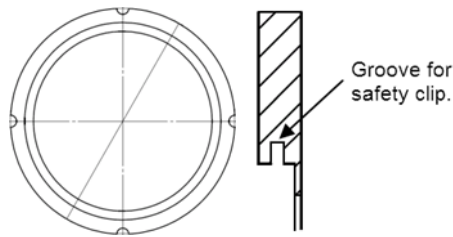

Outer diameter: 115 mm. Inner diameter: 91.5 mm. Wafer size: 100.5 mm (<4"). Total thickness: 2 mm. Substrate thickness: up to 0.5 mm with safety clip, or up to 1.7 mm without safety clip. Material: molybdenum.

PN05056-S *Wafer holder for 4" wafers (molybdenum)*

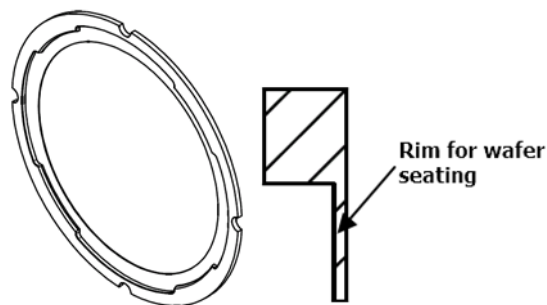

Outer diameter: 115 mm. Inner diameter: 91.5 mm. Wafer size: 100.6 mm (<4"). Total thickness: 2 mm. Material: molybdenum.

R215570-S *Wafer holder for 2" wafers (molybdenum)*

(Only available in set R215576-S Wafer holder assembly for 2" wafer)

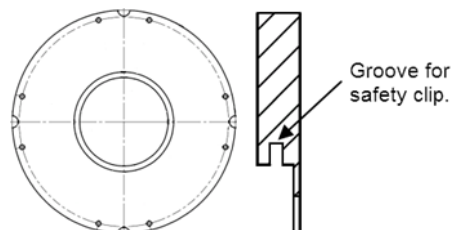

Outer diameter: 115 mm. Inner diameter: 45.6 mm. Wafer size: 51.3 mm (2"). Total thickness: 2 mm. Substrate thickness: up to 0.7 mm with safety clip, or up to 1.7 mm without safety clip. Material: molybdenum.

R215576-S Wafer holder assembly for 2" wafers (molybdenum)

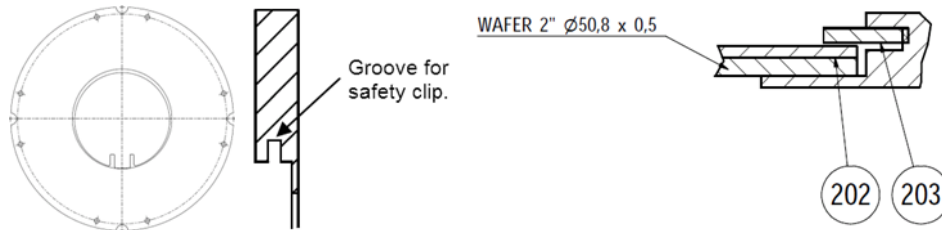

Set consisting of 1x R215570 -S wafer holder, 1x R215575 -S wafer cover (202, 50.8 x 0.3 mm), 1x R215574 -S wafer circlip for 2" wafer (203).

R215571-S Wafer holder for 1/4 segment 2" wafer (molybdenum)

(Only available in set R215577-S Wafer holder assembly for ¼ segment 2" wafer)

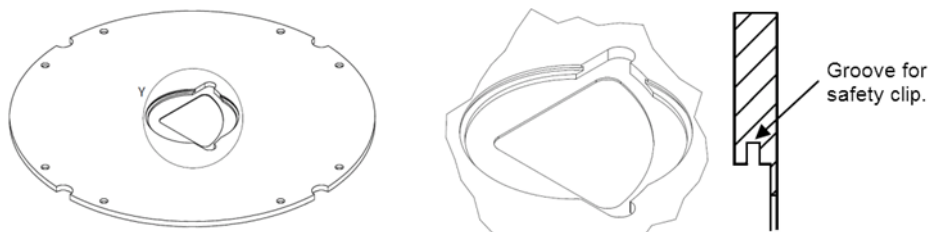

Outer diameter: 115 mm. Wafer size: 51.4 mm (2"), ¼ segment. Total thickness: 2 mm. Substrate thickness: up to 0.7 mm with safety clip, or up to 1.7 mm without safety clip. Material: molybdenum.

R215577-S Wafer holder assembly for 1/4 segment 2" wafer (molybdenum)

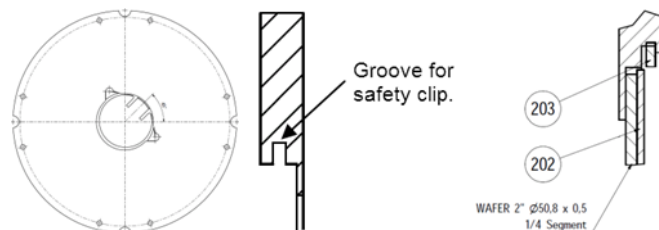

Set consisting of 1x R215571 -S wafer holder, 1x R215573 -S wafer cover (202, ¼ segment of 2"), 1x R215575 -S wafer circlip for 1.1" wafer (203).

R215592-S Wafer holder for 1/2 segment 2" wafer (molybdenum)

(Only available in set R215594-S Wafer holder assembly for 1/2 segment 2" wafer)

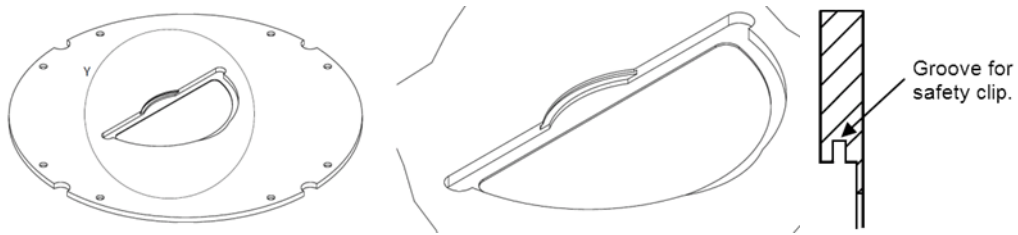

Outer diameter: 115 mm. Wafer size: 51.4 mm (2"), ¼ segment. Total thickness: 2 mm. Substrate thickness: up to 0.7 mm with safety clip, or up to 1.7 mm without safety clip. Material: molybdenum.

R215594-S Wafer holder assembly for ½ segment 2" wafer (molybdenum)

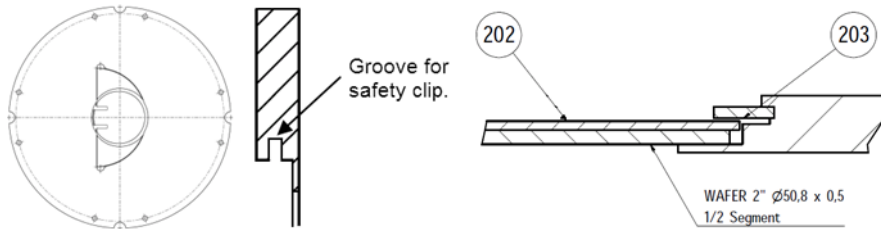

Set consisting of 1x R215592 S wafer holder, 1x R215533 S wafer cover (202, 1/2 -Segment of 2", 0.3 mm), 1x R215575 -S wafer circlip for 1.1" wafer (203).

CA02191-S Wafer retaining spring for 4"

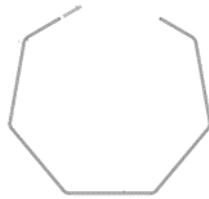

Can be used as a safety clip for wafer holders with groove.

UHV parts

CF parts

Standard copper gaskets

UHV oxygen free copper gaskets for CF flanges, 2mm thickness

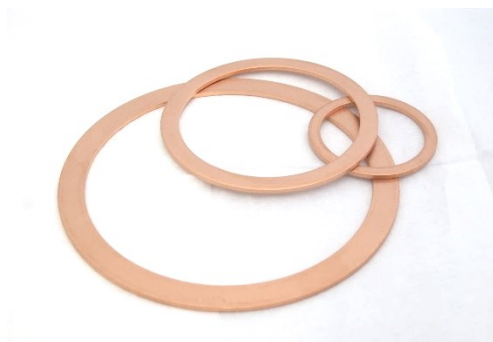

Part number	Type	Inner diameter (mm)	Outer diameter (mm)
F1300-S	CF34/ DN16	16	21.3
F1301-S	CF70/ DN40	39	48.1
F1302-S	CF114/ DN63	67.3	82.4
F1303-S	CF150/ DN100	101.6	120.5
F1304-S	CF200/ DN150	152.6	171.3
F1305-S	CF250/ DN200	203.4	220.1
F209900-S	CF300/ DN250	254	270.1
CA05665-S	CF305/ NW250	254	272.7
F1306-S (surface etched)	CF336/ DN276	276	294.0
F130500-S	CF364/ DN300	305	321.1

Please note: For large flanges, deviations from the norm are not uncommon. In case of doubt, please contact Scienta Omicron Services with information about the chamber flange in question.

S123100-S **Copper gasket package**

Contains:

- 10x **F1300-S** Copper gasket DN16CF
- 10x **F1301-S** Copper gasket DN40CF
- 10x **F1302-S** Copper gasket DN63CF
- 10x **F1303-S** Copper gasket DN100CF
- 10x **F1304-S** Copper gasket DN150CF

F1309-S **Viton gasket DN36CF**

Alternative CF flange gasket for fast entry locks. Inner diameter 63 mm, outer diameter 82 mm. Bakeable up to 150°C (temporarily up to 200°C). Can be reused multiple times.

CA10040 **Viton gasket for viewport door DN100CF**

Gasket for viewport door on ESCA+ fast entry lock. Inner diameter 107.5 mm, thickness 3.53 mm.

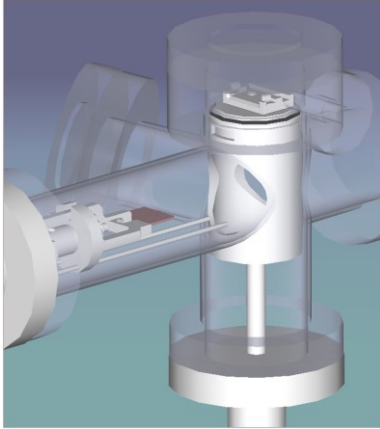
CA12905 **Viton gasket for viewport door DN150CF****PN04484-S** **Viton O-rings for inline FEL**

O-rings for inline fast entry load lock
(black part of image to the left.)
Dimensions: 33 x 2 mm.
Set of 5.

Blank CF flanges

Part number	Type	Flange thickness (mm)	Bolt hole diameter (mm)
F1130-S	CF34/ DN16	7.6	4.3 (M4)
F1131-S	CF70/ DN40	13	6.8 (M6)
F1132-S	CF114/ DN63	17.5	8.4 (M8)
F1133-S	CF150/ DN100	20	8.4 (M8)
F1134-S	CF200/ DN150	22	8.4 (M8)
F1135-S	CF250/ DN200	24.5	8.4 (M8)

Viewport CF flanges

Part number	Type	View diameter (mm)
<i>F118401-S</i>	CF34/ DN16	16
<i>F1184-S</i>	CF70/ DN40	40
<i>F1180-S</i>	CF114/ DN63	70
<i>F1181-S</i>	CF150/ DN100	100
<i>F1183-S</i>	CF200/ DN150	150

Viewport CF flanges with lead glass

Part number	Type	View diameter (mm)
<i>R218752-S</i>	CF34/ DN16	15
<i>R218753-S</i>	CF70/ DN40	32
<i>R218754-S</i>	CF114/ DN63	63
<i>R218745-S</i>	CF150/ DN100	89
<i>R218755-S</i>	CF200/ DN150	136

Valves**Gate valves****Manual gate valves**

Bakeable up to 200°C.

Part number	Type
<i>F1850-S</i>	DN40CF
<i>F9032-S</i>	DN63CF
<i>F1854-S</i>	DN100CF

**F1856-S**

DN160CF

Pneumatic gate valves

Gate valves with pneumatic actuators. No accessories included.

**Part number****Type****F185100-S**

DN40CF

F185300-S

DN63CF

F903302-S

DN100CF

F185700-S

DN160CF

Gate valve gaskets

Set of gaskets for gate valve. The set contains the gasket plate and housing gasket.

F185002-S

DN40CF

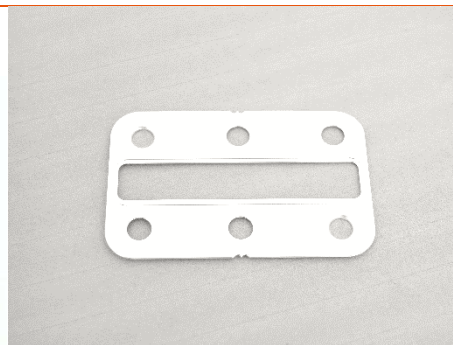
**PN04095-S**

DN63CF



F130900-S

DN100CF

**PN00401-S**

DN160CF

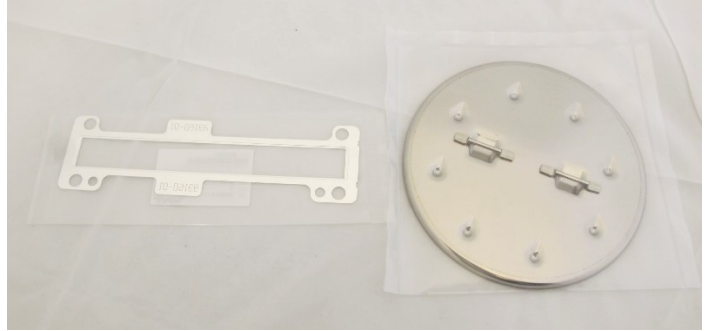
**F185108-S**

DN100CF

Aluminum housing
gasket only



Right angle valves

F2020-S **All metal right angle valve DN16CF**

Fully welded all metal right angle valve with rotatable DN16CF flanges. Bakeable up to 300°C closed and 450°C open. Spare copper pad **PN04871-S** available.



F182000-S **All metal right angle valve DN40CF**

Fully welded all metal right angle valve with rotatable DN40CF flanges. Bakeable up to 300°C closed and 450°C open. Spare copper pad **F182002-S** available.



Gas inlet valves

D0005-S *Manual valve (NuPro)*



Bakeable gas inlet valve with Swagelok connectors.

F2114-S *All metal leak valve*

All metal right angle leak valve DN16CF. Replaces D7316-S for instruments like ISE 5/10/100 and HIS13.

Up to 10 bar inlet pressure. Bakeable up to 250°C closed and 450°C open. Always bake with both ports under vacuum.



F211400-S *Service kit for leak valve*

Service kit for leak valve F2114-S. Contains diaphragm core, pad and gold seal. Recommended for valves which fail after a high number of bake-out cycles.

D7316-S ***Fine dosing valve DN35CFF***

For instruments like ISE 5/10/100 and HIS13 replaced by F2114-S. Only to be mounted directly on the chamber.



Pressure measurement

Ion gauge

PN00228-S *Ion gauge head VIG18 UHV*

Bayard-Alpert ion gauge for vacuum range 1×10^{-3} to 3×10^{-11} mbar, mounted on DN40CF flange. The gauge is equipped with two Thoria coated Iridium filaments which are outgassed by electron-bombardment.

When mounting, orient the gauge such that the filaments are beside or below the grid structure.

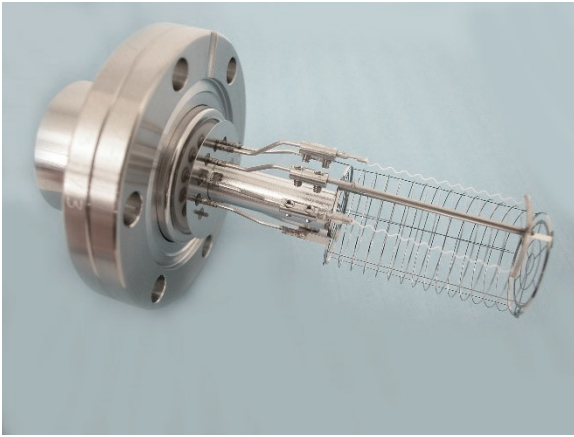

PN00424-S *Filaments for ion gauge*

Spare twin Thoria coated Iridium filament set for ion gauge PN00228-S. Replaces F2017.

Run new filaments at low emission currents and steadily increase the current to maximum until fully outgassed. Only afterwards apply electron-bombardment degas.

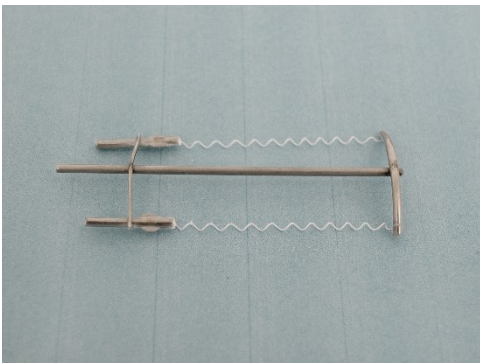

PN05081-S *Ion gauge controller PVCX*

19" rack ion gauge controller. Includes support for one UHV ion gauge, one Pirani gauge and one thermocouple for bake-out control.



Pirani gauge

PN04310-S Pirani gauge VSP521

Pre-adjusted Pirani sensor with temperature compensation, for vacuum range 100 to 0.001 mbar.
Mounted on DN16KF flange.



Pumps

Ion Getter Pumps

PN00109-S *Cable for ion getter pump*

High voltage cable for TiTan IGP. Fully bakeable.

PN06417-S	3 m
PN03060-S	6 m
PN04583-S	8 m
PN04869-S	10 m
PN04839-S	15 m

Titanium Sublimation Pumps

F2000-S *Titanium sublimation pump ZST22*

Three filament Titanium sublimation pump for secondary pumping.

Mounted on DN40CF flange. Insertion depth from flange: 203 mm



PN04404-S *TSP filaments*

Set of 12 Titanium molybdenum alloy filaments for Titanium sublimation pump **F2000-S**. Replaces **F200008-S**.

TSP filaments need to be exchanged on a regular basis. Typical signs of wear are fragmentation and bending out of shape, up to breaking.



Scroll pumps

CA00092-S *Tip seal kit for scroll pumps XDS*

Suitable for scroll pumps XDS5, XDS10.

PN04865-S *Tip seal kit for scroll pumps nXDS*

Suitable for scroll pumps nXDS6i, nXDS10i, nXDS15i, nXDS20i.

Bake-out

F9016-S **Thermocouple type K**

Ring-shaped thermocouple (6 mm inner diameter) for system bake, 2m cable with K-type thermocouple plug.

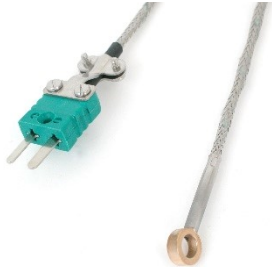

D0013-S **Ring heater element**

240 V/ 2.5 kW ring heater element for bench fan heaters and bake-out tent fan heaters.

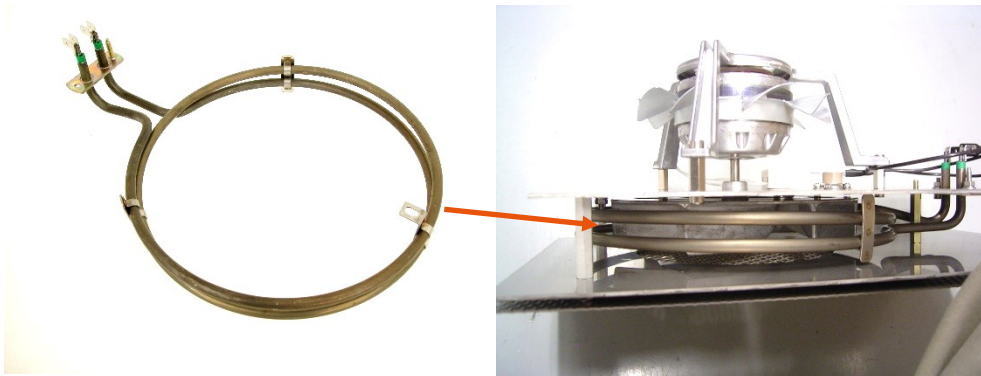

Please note: Systems built after 2017 might have newer version of ring heater which is available on request.

CA13352-S **Finned heater 750 W**

Heater element commonly used inside a closed bench below system. Replaces **D7501-S**.

Please note: Adapter for screw connection for older systems's heaters is not included.



CA13353-S **Finned heater 250 W**

Heater element commonly used inside a closed bench below system. Replaces **D7502-S**.

Please note: Adapter for screw connection for older systems's heaters is not included.

Heater shrouds

Shrouds for high power probes with internal heater band and silicon-sealed isolating jacket.

Part number	Length	Heater power
PN06741	200 mm	40 W
PN05639	300 mm	40 W
CA12863	400 mm	60 W
PN06283	450 mm	60 W
PN05716	550 mm	80 W
CA13309	600 mm	80 W
CA05104	700 mm	100 W
PN05678	800 mm	100 W
CA12864	900 mm	100 W
CA12865	1100 mm	150 W
CA04355	1300 mm	150 W
PN06636	1500 mm	200 W
PN06637	1750 mm	250 W
CA13653	1900 mm	250 W



System accessories

F9049-S **System bench levelling foot**

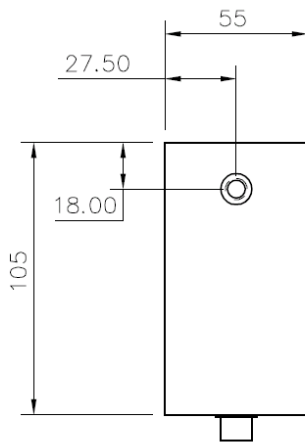

Up to 4000 N load; adjustable height 102 mm +4/ -5 mm.

PN04489-S **Phase fault relay**

200-500 V AC phase fault relay for pre-Mistral mains rack.

Manipulator Sample Stages

Scienta Omicron offers a multitude of sample stages with various heating and cooling options. Custom solutions and spare parts for individual stages are always possible upon request. This section lists the standard version of our heater stages most commonly used in Scienta Omicron systems.

Overview

	Resistive PBN heater	E-beam heater	High temperature heater
Spare filament	<i>E2211-S</i>	<i>F200102-S</i>	<i>PN05532-S</i>
Heater module	<i>E2929-S</i> (one rot. axis) <i>PN00374-S</i> (two rot. axis)	<i>PN02038-S</i> (one rot. axis) <i>PN06854</i> (two rot. axis)	-
Heater Facility	<i>PN01719-S</i>	<i>PN01720-S</i>	-
Upgrade package	<i>PN06739-S</i>	<i>PN06358-S</i>	<i>PN05562-S</i>
Ex-vacuum cables	<i>K7821-S</i> (current) <i>K781200-S</i> (previous)	<i>PN03982</i> (for e-beam) <i>CA09272</i> (for DH)	<i>PN04350-S</i>
Power supply	<i>PN02985-S</i> (750 W)	<i>CA06938</i>	<i>PN02985-S</i> (750 W)

Resistive tungsten wire sample heater

S7106 Resistive wire heater

Please note: For most applications, the resistive tungsten wire sample heater S7106 was replaced by the PBN sample heater. An upgrade package from resistive tungsten wire heater to PBN heater PN06739-S is available, see below.

Available spare part:

F200103-S Spare filament for resistive wire heater S7106

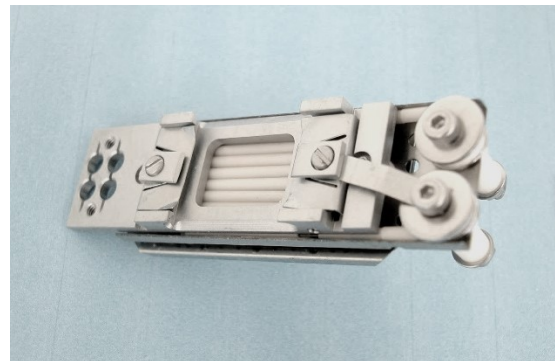

Resistive PBN sample heater

PN01719-S Resistive PBN sample heater facility for primary rotation (RH 1 C)

The PN01719-S resistive sample heater facility (RH 1 C), including sample heater and support arm, is ready to be mounted to a manipulator rotary drive rod with 9.5 mm in diameter. The direct heating (DH) brush is included. Please specify orientation of heater brush upon order. Wires for electrical connections are not included.

- 100 W pyrolytic boron nitride (PBN) heater (temporarily: 110 W)
- Maximum current: 5 A
- Maximum sample plate temperature: 1130 K (1100 K with LN2 cooling facility installed)

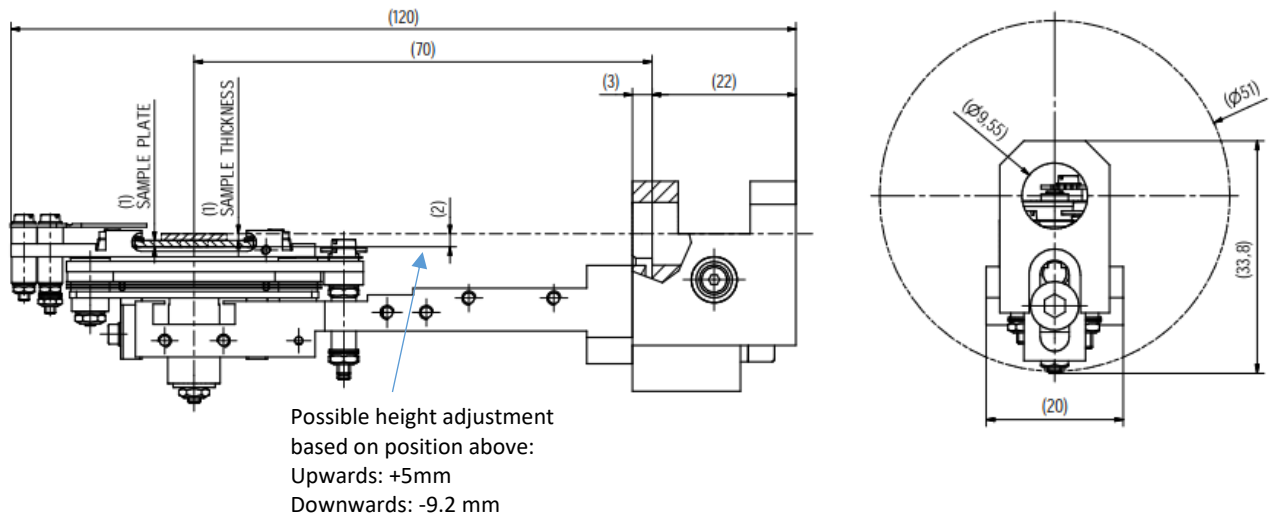

PN06739-S PBN sample heating upgrade package

For standard Scienta Omicron manipulators, specifically ones outfitted with the S7106 W wire heater, the resistive PBN sample heater is available as a predefined upgrade package.

The package contains:

- E2929-S resistive sample heater for primary rotation
- Support arm E2364
- Parts for custom in-vacuum wiring of heater
- Thermocouple
- Ceramics set.

Please refer to the respective Upgrade Flyer for details.

Spare parts for resistive PBN sample heaters

The following spare parts are available for PN01719-S resistive PBN sample heater facility:

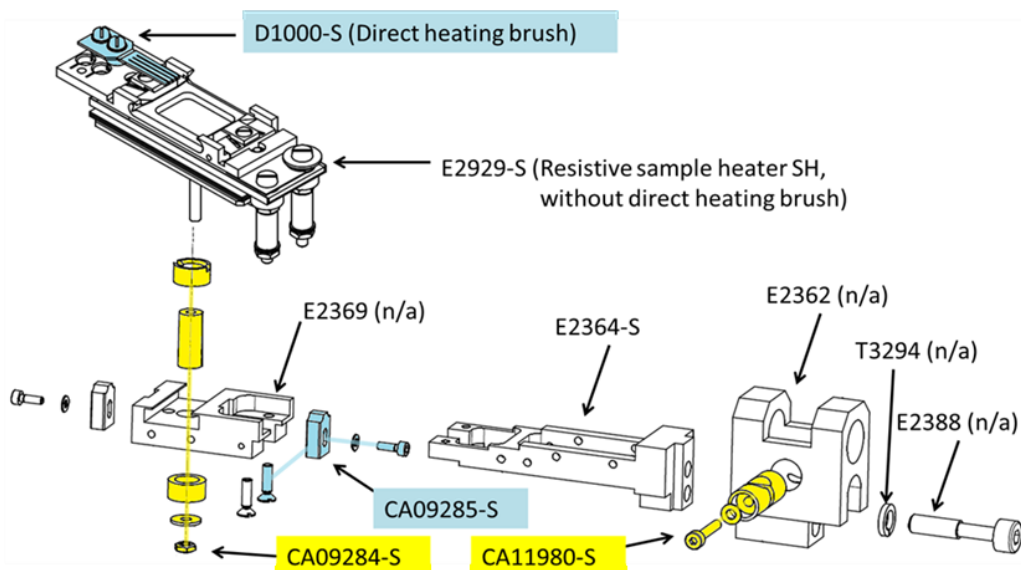

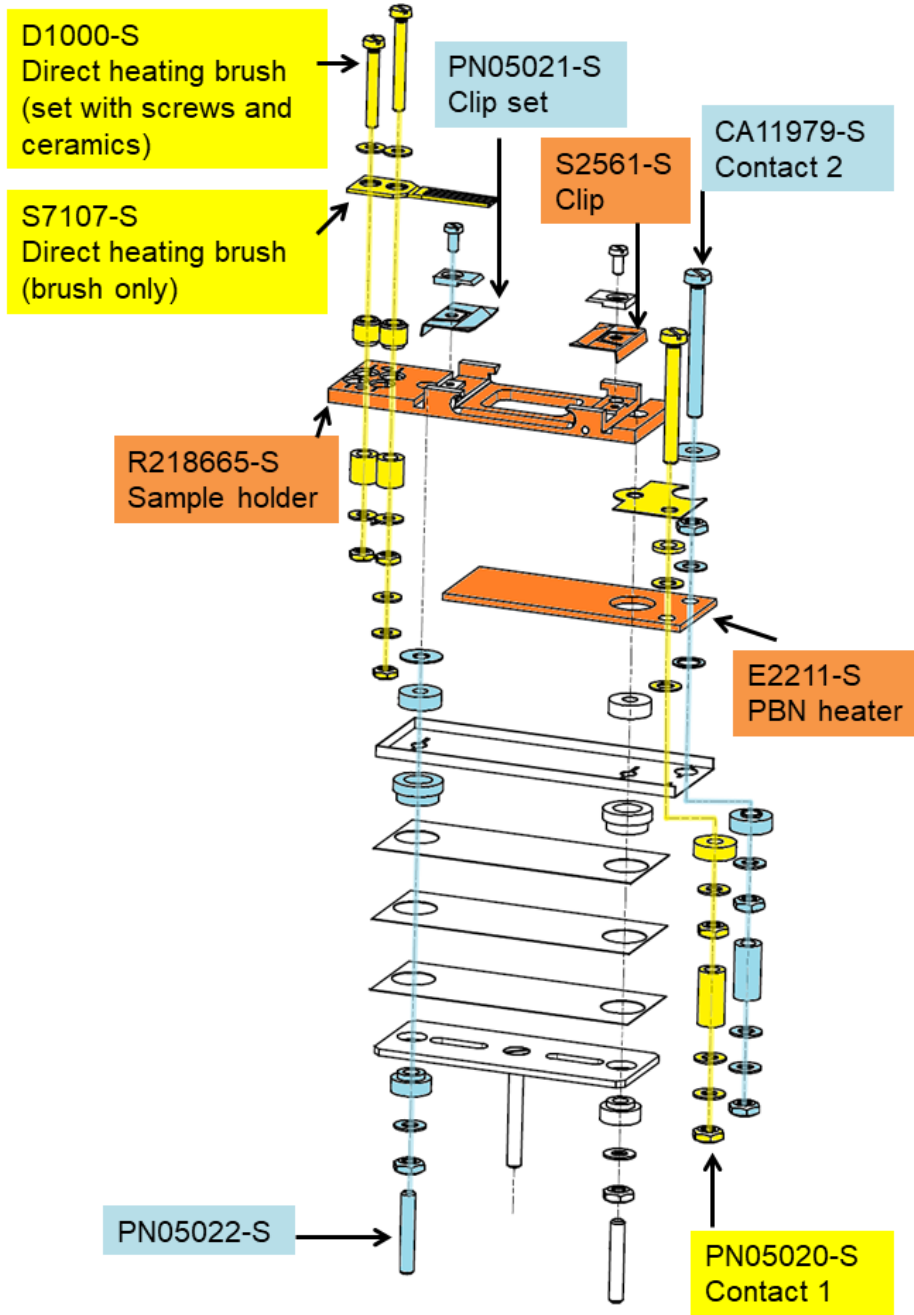

E2929-S **Resistive sample heater for primary rotation**

Please note that the direct heating brush D1000-S has to be ordered in addition.

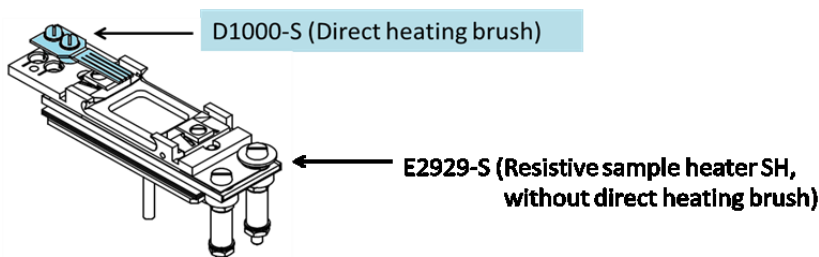

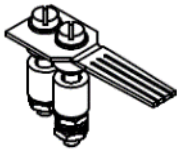
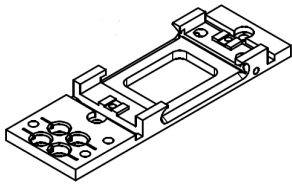
D1000-S **Direct heating brush set****PN05021-S** **Sample clip set****R218665-S** **Sample holder (replaces S2180-S)****CA09554-S** **Ceramic set for resistive sample heater (primary rotation)**

This set consists of the ceramics contained in 2x PN05022-S, 1x PN05020-S and 1x CA11979-S. Only ceramics, no other parts are included.

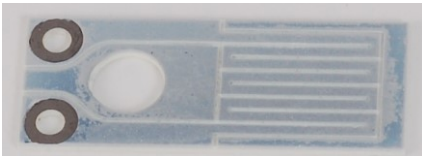
E2211-S **PBN heater element****PN01721-S** **Resistive PBN sample heater facility for secondary rotation (RH 2 C)**

The PN01721-S resistive sample heater facility for secondary rotation (RH 2 C), including sample heater and support arm, is pre-assembled and can be mounted on a HPT, Omniax, MiniAx or Transax manipulator with double axis rotation. The direct heating (DH) brush is already included. Wires for electrical connections are not included.

- 100 W pyrolytic boron nitride (PBN) heater (temporarily: 110 W)
- Maximum current: 5 A
- Maximum sample plate temperature: 1130 K (1100 K with LN2 cooling facility installed)

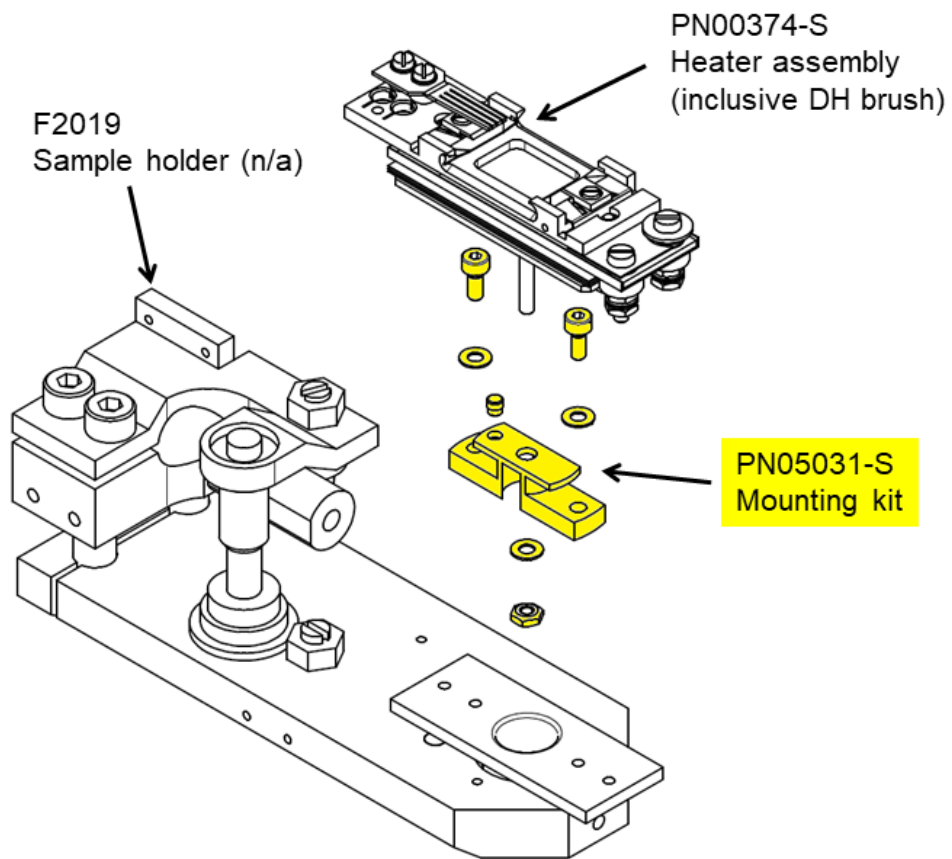

Spare parts for Resistive PBN sample heater for secondary rotation:

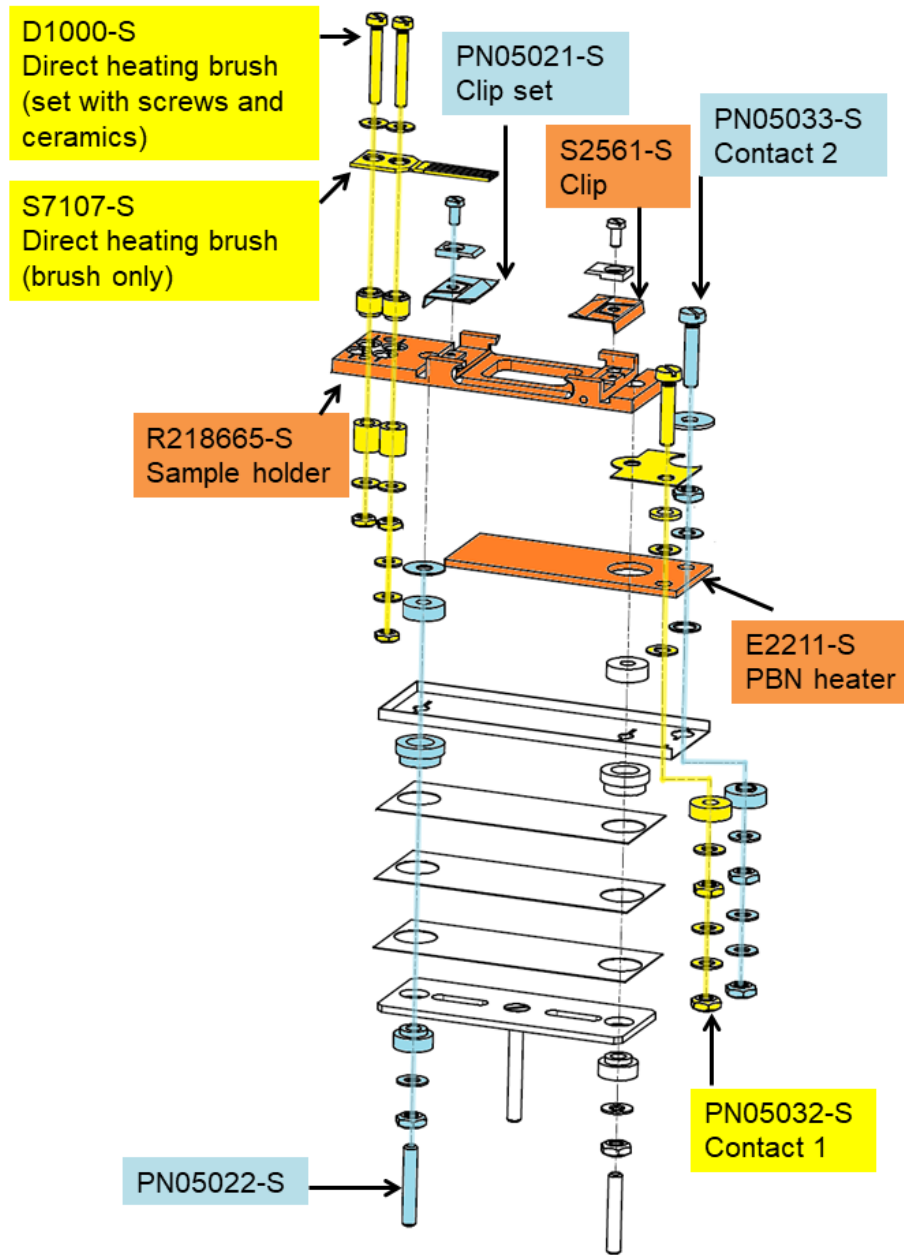

PN00374-S Resistive sample heater for secondary rotation

D1000-S is included in PN00374-S.

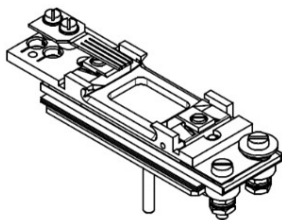

E-beam sample heater

PN01720-S E-beam sample heating facility (EBH 1 C)

The PN01720-S e-beam sample heater facility (EBH 1 C), including sample heater and support arm, is ready to be mounted to a manipulator rotary drive rod with 9.5 mm in diameter. The direct heating (DH) brush is already included. Wires for electrical connections are not included.

- The filament can be biased up to -650 V
- Maximum heating power: 100 W
- Maximum sample plate temperature: 1370 K (1300 K with LN2 cooling facility installed).

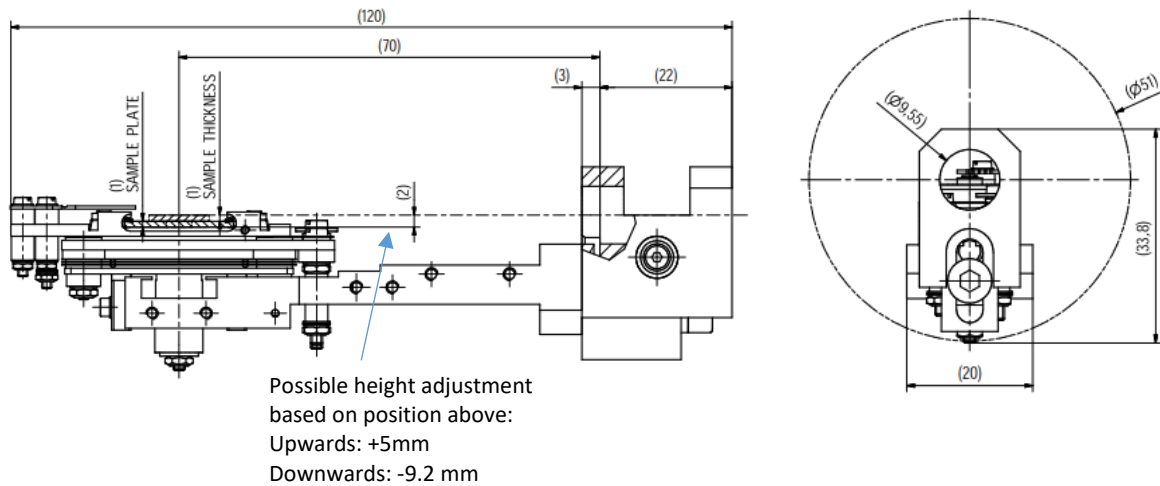

PN06358-S E-Beam heating upgrade package

For standard Scienta Omicron manipulators, the e-Beam sample heater is available as a predefined upgrade package.

The package contains:

- PN02038-S e-Beam sample heater for primary rotation
- Material for custom internal wiring of heater
- Ceramics set
- 6 pin DN16CF feedthrough with optional CF elbow
- Power supply for e-Beam heating
- Cables for e-Beam and direct current heating.

Please refer to the respective Upgrade Flyer for details.

Spare parts for E-Beam sample heaters

The following spare parts are available for PN01720-S e-beam sample heating facility (EBH 1 C):

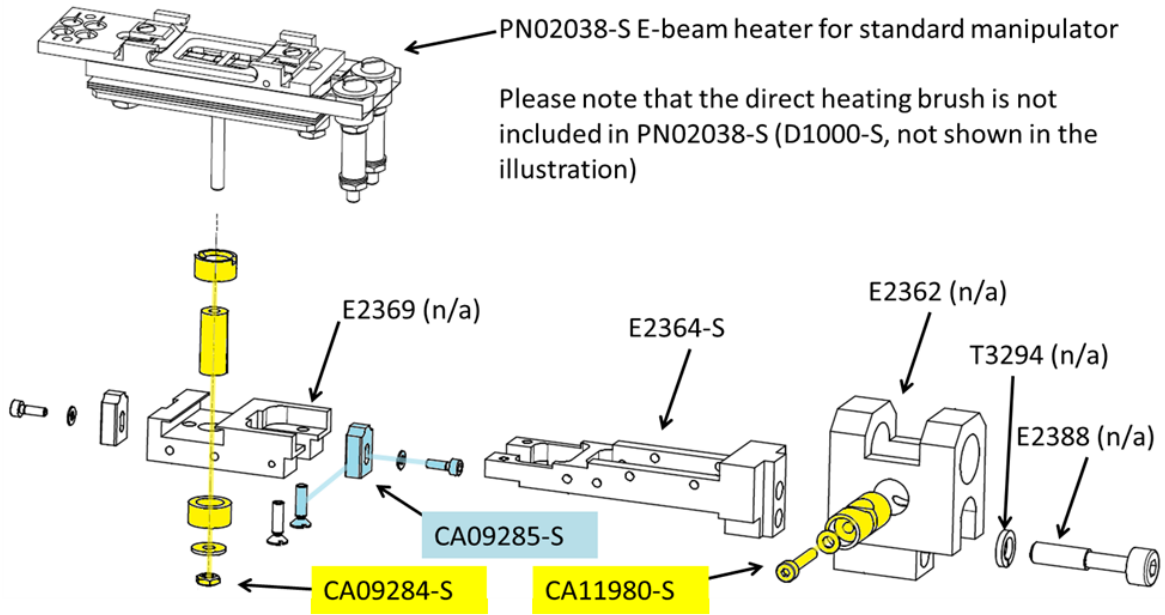

PN02038-S E-Beam sample heater for standard manipulator

Please note that the direct heating brush has to be ordered in addition (D1000-S, not shown in the illustration below).

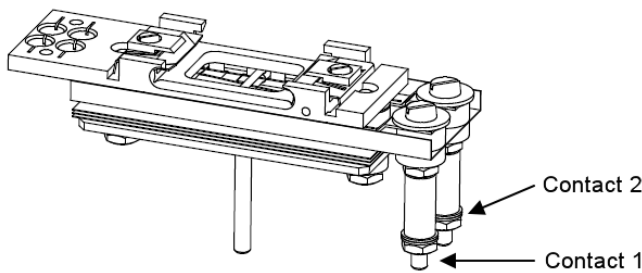

The following spare parts for PN02038-S E-Beam Heater are available:

PN05028-S Contact 1 for e-beam heater

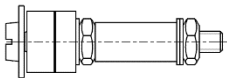

PN05029-S Contact 2 for e-beam heater

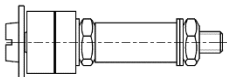

D1000-S Direct heating brush set

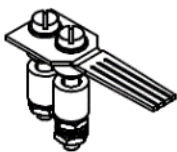

PN05021-S Sample clip set



R218665-S **Sample holder (replaces S2180-S)**

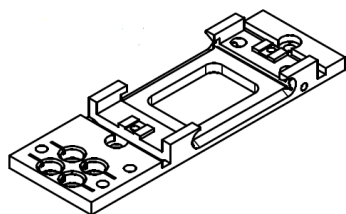

CA04139-S **Filament support ceramics**

Approximately 16 mm long and 1 mm in diameter. Minimum order quantity: 6.

F200102-S **Filament for e-beam heater**

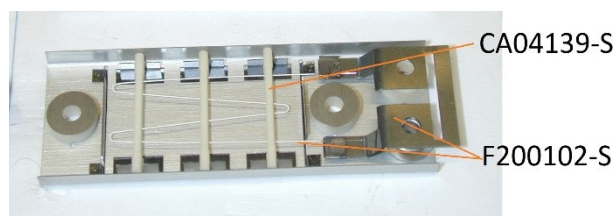

Filament housing and filament support ceramics not included. To mount the filament, a total of 6 CA04139-S filament support ceramics are required.

PN05030-S **Base mount set for e-beam sample heater**

This corresponds to PN05022-S of the standard heater (E2929-S) – the only difference is the topmost ceramic.

PN06854 **E-beam heater facility for secondary rotation (EBH 2 C)**

Please note that some spare parts and ceramics for the E-beam heater for secondary rotation are different than the ones for primary rotation. Please contact Scienta Omicron Services for support.

High temperature sample heater (1670 K)

PM05562-S **High temperature sample heating upgrade package (1670 K)**

The high temperature sample heating facility (HTSH) allows samples to be continuously heated up to 1670 K by means of radiation.

The sample acceptor is made from molybdenum. The maximum filament power is 270 W (11 A; 24,5 V). The sample and one side of the filament are grounded. A thermocouple type K is fitted for temperature measurement. The upgrade package contains a pre-assembled heater facility, ready to be mounted to a manipulator with primary rotation (D = 9.5 mm). Material for internal wiring, feedthrough and heater power cable are included. The direct heating brush is also included. Please specify orientation of heater brush upon order.

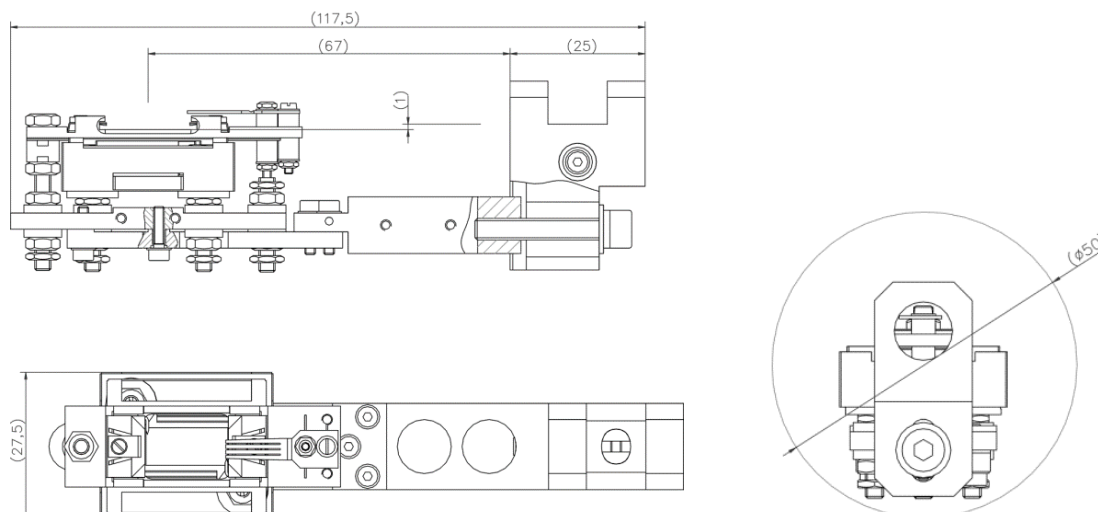

Please refer to the respective Upgrade Flyer for details.

Spare parts for high temperature sample heaters

PN05532-S Spare filament kit for high temperature sample heater (1670 K)

This kit contains:

- 5x tungsten filament
- 1x molybdenum studs M3 x 29
- 1x molybdenum studs M3 – M1.6 x 31.5
- 2x filament mount
- 6x molybdenum lock nut M3
- 4x molybdenum nuts M3
- 2x molybdenum nuts M1.6

Please note, that these parts are not sold separately. This set is composed under consideration of the different lifetimes of the parts.

High Temperature Sample Heater (2500 K)

CA09051-S Spare filament kit for high temperature sample heater (2500 K)

This kit contains:

- 5x tungsten filament
- 2x molybdenum studs M3 x 38
- 2x filament mount
- 4x molybdenum lock nut M3
- 8x molybdenum nuts M3

Please note, that these parts are not sold separately. This set is composed under consideration of the different lifetimes of the parts.

Manipulator electrical connections

In-vacuum wiring

During HT heater operation, the wires close to the heater will also heat up. The last few cm are therefore isolated by ceramics. For high temperature heaters, also the wire itself is replaced by a heat resistant material which is attached with barrel connectors.

Please contact Scienta Omicron Services for detailed support.

CA00432-S *K-type thermocouple module*

Contains thermocouple cable (3m), thermocouple element and ceramics.



CA07120-S *Crimp connector for feedthroughs (UHV-side)*

- Minimum order quantity: 4 pieces
- Gold-plated copper.
- Maximum diameter of wire: 1.3 mm
- Pin diameter: 1.3 – 1.5 mm



PN00480-S *Chromel crimp connector for feedthroughs (UHV-side)*

PN00478-S *Alumel crimp connector for feedthroughs (UHV-side)*

Ceramics for manipulator wiring

Ceramics are used to insulate wires where high temperatures do not allow insulation by PTFE or Kapton coating, i.e. usually close to the heater element.

S711002-S *Ceramic for sample heater wire*

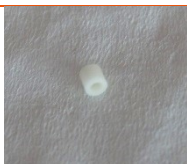

- Minimum order quantity: 75 pieces.
- Outer diameter: 2.0 mm
- Inner diameter: 1.0 mm
- Length: 2.0 mm

S7112-S *Ceramic for sample heater wire (2 holes)*



- Minimum order quantity: 75 pieces.
- Outer dimensions: 4.2 x 2.3 mm
- Inner diameter: 2x 1.3 mm
- Length: 5.0 mm

CA03643-S *Ceramic for thermocouple wire (2 holes)*

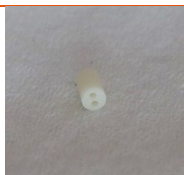

- Minimum order quantity: 75 pieces.
- Outer diameter: 1.6 mm
- Inner diameter: 2x 0.4 mm
- Length: 3.0 mm

Standard Feedthroughs and Cables

Overview

	Version	Feedthrough	Cable
For PBN heater (4 pin)	Current (MS circular)	F1004-S	K7812-S
	Previous (Fischer)	F2011-S	K781200-S
For e-beam heater (6 pin)	Current	CA07002-S	PN03982 (e-beam heating) CA09272 (direct heating)
	Current	CA07002-S	PN04350-S
For type K thermocouple	Current (MS circular)	PN06390-S	PN06389-S (Dual)
	Previous (LEMO)	PN05676-S	PN05640-S (Single) PN05641-S (Dual)
	Obsolete (Fischer)	F2010-S	K781300-S (Single) CA03433-S (Dual)

F1004-S *4 pin feedthrough for heater (MS circular, DN16CF)*

Used for current versions of PBN heaters. Without plug.



K7812-S PBN heater cable (MS circular)

Suitable for F1004-S 4 pin heater feedthrough. Length: 6 m

**F2011-S 4pin feedthrough for heater (Fischer, DN16CF)**

Used for previous version of PBN heaters. Plug included.

**K781200-S PBN heater cable (Fischer)**

Suitable for F2011-S 4 pin heater feedthrough. Length: 6 m

**CA07002-S 6pin feedthrough for heater (MIL-C-5015-type, DN16CF)**

Used for e-beam heaters and high temperature heaters. Without plug.



F1223-S **Right angle adapter DN16CF-DN16CF**

Can be used in situations where feedthroughs cannot be mounted directly due to geometrical constraints, SL: 38 mm.

PN03982 e-beam heater cable

Suitable for CA07002-S 6pin feedthrough, to connect to e-beam heater power supply. Length: 8 m.



CA09272 direct current heater cable

Suitable for CA07002-S 6pin feedthrough, for direct current heating option. Length: 8 m



PN04350-S **High temperature heater cable**

Suitable for CA07002-S 6pin feedthrough, Length: 8 m



PN06390-S 4pin feedthrough for thermocouple (MS circular, DN16CF)

Used for current version of type K thermocouples. Without plug.

PN06389-S Thermocouple cable (MS circular)

Suitable for PN06390-S 4pin feedthrough, type K, length: 6 m.



PN05676-S 4pin feedthrough for thermocouple (Lemo-type, DN16CF)

Used for previous version of type K thermocouples. Plug included.

Note: F2010-S (Fischer-type) is not available anymore and has been replaced.



PN05641-S Thermocouple cable (LEMO; dual TC)

Suitable for PN05676-S 4pin thermocouple feedthrough, type K. Length: 6 m. Also available as single TC option (PN05640-S)

Note: Replaces CA03433-S (Fischer type plug) for F2010-S.



Power Supplies for Manipulator heaters

Other power supplies (more power, higher voltage or current) are available upon request.

PN02985-S ***Power supply 750 W***

- Programmable power supply for rack-mounting (19" x 1U) with integrated RS-232 and RS-485 interface.
- Output : 0-60 V, 0-12.5 A (DC).

PN03157-S ***Power supply 1500 W***

- Programmable power supply for rack-mounting (19" x 1U) with integrated RS-232 and RS-485 interface.
- Output : 0-60 V, 0-25 A (DC).

Liquid nitrogen cooling

F250100-S ***LN₂ cooling accessory kit***

For manipulators with liquid nitrogen cooling, hose diameter 1/8" (for example Omniax, Mini-ax, Transax and HPT).

PN06651 ***LN₂ cooling accessory kit***

For manipulators with liquid nitrogen cooling, hose diameter 6 mm.

Contains:

- Styrofoam bucket
- Spiral tube
- Hose with isolation material



CA00482-S **VCR gasket**

Copper gasket for in-vacuum nitrogen line connectors

Evaporators

EFM Evaporators

Standard crucibles

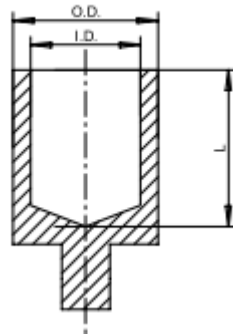

B000425-S	Al ₂ O ₃ small	Capacity 0.06 cc., ID 3.0 mm, O.D. 7.5 mm, L 5.5 mm, T _{max} @ 10E-4 Torr, vapor pressure 1320°C Material: Mo-liner with aluminium oxide insert
B000426-S	Al ₂ O ₃ medium	Capacity 0.15 cc., ID 5.0 mm, O.D. 9.0 mm, L 8.0 mm, T _{max} @ 10E-4 Torr, vapor pressure 1320°C Material: Mo-liner with aluminium oxide insert Not suitable for EFM 3T and EFM 3i!
B000427-S	Al ₂ O ₃ large	Capacity 0.28 cc., ID 6.0 mm, O.D. 10.0 mm, L 10.0 mm, T _{max} @ 10E-4 Torr, vapor pressure 1320°C Material: Mo-liner with aluminium oxide insert Not suitable for EFM 3T and EFM 3i!
B000428-S	Al ₂ O ₃ extra large	Capacity 0.65 cc., ID 10.0 mm, O.D. 11.0 mm, L 13.0 mm, T _{max} @ 10E-4 Torr, vapor pressure 1320°C Material: Mo-liner with aluminium oxide insert Not suitable for EFM 3T and EFM 3i!
B000429-S	PBN small	Capacity 0.19 cc., ID 4.5 mm, O.D. 7.5 mm, L 7.0 mm, T _{max} @ 10E-4 Torr, vapor pressure 1600°C Material: Mo-liner with PBN insert and tantalum clip For EFM3T and EFM 3i only!
B000430-S	PBN medium	Capacity 0.19 cc., ID 5.5 mm, O.D. 8.5 mm, L 8.0 mm, T _{max} @ 10E-4 Torr, vapor pressure 1600°C Material: Mo-liner with PBN insert and tantalum clip Not suitable for EFM 3T and EFM 3i!
B000431-S	PBN large	Capacity 0.6 cc., ID 8.0 mm, O.D. 11.0 mm, L 12.0 mm, T _{max} @ 10E-4 Torr, vapor pressure 1600°C Material: Mo-liner with PBN insert and tantalum clip Not suitable for EFM 3T and EFM 3i!

B000434-S	Mo small	Capacity 0.075 cc., ID 4.0 mm, O.D. 6.0 mm, L 6.5 mm, T _{max} @ 10E-4 Torr, vapor pressure 2120°C
B000432-S	Mo medium	Capacity 0.25 cc., ID 6.0 mm, O.D. 8.0 mm, L 9.0 mm, T _{max} @ 10E-4 Torr, vapor pressure 2120°C
B000433-S	Mo large	Capacity 0.6 cc., ID 8.0 mm, O.D. 10.0 mm, L 12.0 mm, T _{max} @ 10E-4 Torr, vapor pressure 2120°C Not suitable for EFM 3T and EFM 3i!
B000435-S	Graphite small	Capacity 0.075 cc., ID 4.0 mm, O.D. 6.0 mm, L 6.5 mm, T _{max} @ 10E-4 Torr, vapor pressure 1800°C
B000436-S	Graphite medium	Capacity 0.125 cc., ID 4.5 mm, O.D. 6.0 mm, L 8.0 mm, T _{max} @ 10E-4 Torr, vapor pressure 1800°C
B000437-S	Graphite large	Capacity 0.3 cc., ID 6.0 mm, O.D. 8.0 mm, L 9.0 mm, T _{max} @ 10E-4 Torr, vapor pressure 1800°C Not suitable for EFM 3T and EFM 3i!
B000438-S	Graphite extra large	Capacity 0.7 cc., ID 9.0 mm, O.D. 11.0 mm, L 12.0 mm, T _{max} @ 10E-4 Torr, vapor pressure 1800°C Not suitable for EFM 3T and EFM 3i!
B000439-S	Tantalum small	Capacity 0.075 cc., ID 4.0 mm, O.D. 6.0 mm, L 6.5 mm, T _{max} @ 10E-4 Torr, vapor pressure 2590°C
B000440-S	Tantalum medium	Capacity 0.25 cc., ID 6.0 mm, O.D. 8.0 mm, L 9.0 mm, T _{max} @ 10E-4 Torr, vapor pressure 2590°C
B000441-S	Tantalum large	Capacity 0.6 cc., ID 8.0 mm, O.D. 10.0 mm, L 12.0 mm, T _{max} @ 10E-4 Torr, vapor pressure 2590°C Not suitable for EFM 3T and EFM 3i!
B000442-S	Stainless steel crucible with nozzle medium	Knudsen like crucible, capacity 0.15 cc, ID 5.0 mm, O.D. 7.0 mm, L 8.0 mm, T _{max} @ 10E-4 Torr, vapor pressure 800° C
B001258-S	BeO small	Capacity 0.085 cc., ID 4.0 mm, O.D. 8.0 mm, L 7.0 mm, T _{max} @ 10E-4 Torr, vapor pressure 1900°C Material: Mo-liner with beryllium oxide insert and tantalum clipmax fill = 1/4 to operate with cold lip!! Hazardous good!! transport and export restrictions
B000443-S	BeO medium	Capacity 0.19 cc., ID 6.0 mm, O.D. 10.0 mm, L 7.0 mm, T _{max} @ 10E-4 Torr, vapor pressure 1900°C Material: Mo-liner with beryllium oxide insert and tantalum clipmax fill = 1/4 to operate with cold lip!! Hazardous good!! Transport and export restrictions Not suitable for EFM 3T and EFM 3i!
B000444-S	ZrO ₂ medium	Capacity 0.11 cc., ID 4.5 mm, O.D. 8.0 mm, L 7.6 mm, T _{max} @ 10E-4 Torr, vapor pressure 1300°C

B000445-S	W small	Capacity 0.11 cc., ID 4.0 mm, O.D. 6.0 mm, L 6.5 mm, T _{max} @ 10E-4 Torr, vapor pressure 1300°C
B000446-S	W medium	Capacity 0.25 cc., ID 6.0 mm, O.D. 8.0 mm, L 9.0 mm, T _{max} @ 10E-4 Torr, vapor pressure 2750°C
B000447-S	W large	Capacity 0.6 cc., ID 8.0 mm, O.D. 10.0 mm, L 12.0 mm, T _{max} @ 10E-4 Torr, vapor pressure 2750°C Not suitable for EFM 3T and EFM 3i!

Barrel connectors for crucibles



B000448-S	Mo barrel connector for EFM3, diameter 1.5 mm	suitable for target wires up to 1.5 mm or crucibles, includes molybdenum set screws Not suitable for EFM 3T!
B000449-S	Stainless Steel barrel connector for EFM	suitable for target wires up to 1.5 mm diameter Not suitable for EFM 3T!
B001259-S	EFM barrel connector molybdenum 2.0 mm	suitable for target wires up to 2.0 mm diameter, includes molybdenum set screws Not suitable for EFM 3T!
B001260-S	EFM barrel connector molybdenum 4.0 mm	suitable for target wires up to 4.0 mm diameter, includes molybdenum set screws Not suitable for EFM 3T!
B001261-S	EFM barrel connector molybdenum 6.0 mm	suitable for target wires up to 6.0 mm, includes molybdenum set screws Not suitable for EFM 3T!
B001629-S	Barrel connector molybdenum 1.5 mm for Triple EFM	spare standard barrel connector for EFM3T, suitable for target wires up to 1.5 mm diameters or crucibles

Spare ceramics for EFM

CA05296-S	Slide bearing ceramics for EFM3T (set of 3)	
CA05297-S	Slide bearing ceramic with Mo rod and connector for EFM3T	

PN04689-S Spare Flux Monitor Ceramics for EFM3

D117510-S Spare Flux Monitor Ceramics for EFM T3

Water cooling spare parts for EFM

PN03322-S T-cross for EFM with quick connectors

PN03321-S T-cross for EFM

B001257-S Quick lock/unlock water hose connectors (QWC)

Filaments for EFM

CA09324-S EFM3 filament with thick wire, 150 µm
Thoriated tungsten filament wire d 0.15 mm
Replaces **B000910-S**.
Suitable for EFM2, EFM3, EFM3s, EFM4, EFM H!
Filaments build after mid-2017 will be no longer compatible with NG EFM power supplies built before 2001.

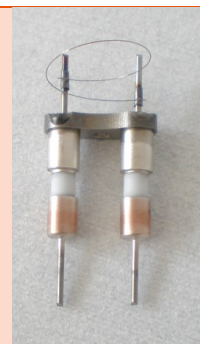

B000911-S filament for EFM 3T
One isolated pin.
Suitable for serial numbers up to and including 0110-2004, SN 0112-2004 and all 4 digit serial numbers up to SN 0310.
Please provide the serial number of the EFM 3T with the purchase order!

B002916-S filament for EFM 3T
Two isolated pins.
Suitable for serial numbers 0111-2004 and all serial number from 0113-2004 onwards

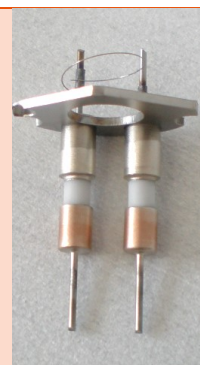

PN00913-S EFM T3 barrel connector for filament
barrel connector for filament, only for EFM 3T

PN00558-S EFM 3/4 barrel connector for filament
barrel connector for filament, only for EFM 3/4

Effusion Cells

Overview

According to the material that is going to be evaporated, one has to choose a suitable

- Source type
- Crucible material and size
- Filament type
- Cooling/ Shutter/ Thermocouple

Choosing the wrong equipment might cause severe damage of the effusion cell. Crucibles of different material and size are available for all of the effusion cells mentioned here on request. Replacement filaments available for onsite replacement are listed below.

Explanation of typical source denotation:

Flange size	Lip diameter	Filament Type (see below)	Crucible type	Diameter y					
NTEZ	40 -	10 -	22 -	K - S -	SF -	K -	P -	Lxxx -	Dyy -
Source name	Crucible size	Integrated options	Thermocouple type	Length x					
		<ul style="list-style-type: none"> • Cooling shroud K • Shutter S 							

Filament Types:

- SF – Standard Filament – Heats the crucible along its entire length.
- CL – Cold Lip Filament – Leaves the lip cooler (required for Al); comes with additional shielding.
- TF – Tip Filament – Only topmost part is heated; provides maximum temperature gradient between crucible lip and bottom.
- HL – Hot Lip Filament – Provides higher temperature at lip compared to bottom with a single power supply; is wired more densely at the top compared to the bottom.
- DF – Dual Filament – two heaters that can be independently heated with two power supplies; provides all operation possibilities SF, CL, TF and HL.

Cable set for Effusion Cell

For different types of cells/ different power - on request

Spare parts and crucibles

List of effusion cells with temperature range, thermocouple type, filament type and filament options. Available standard crucibles are listed with material and capacities.

WEZ

Description	T range	TC type	Filament	Standard crucible
Standard effusion cell	700-1400°C	C	Ta filament (HL, CL, DF, TF)	PBN; 2 – 60 cm ³

PEZ

Description	T range	TC type	Filament	Standard crucible
Production effusion cell	200-1400°C	2x C	Ta wire filament (HL,CL, DF)	PBN; 40 – 1700 cm ³ *

*Customized beam shaping crucible inserts available

NTEZ

Description	T range	TC type	Filament	Standard crucible
Low temperature effusion cell	80-1000°C	K	Ta filament (HL, CL, DF)	PBN; 2 – 200 cm ³

OME

Description	T range	TC type	Filament	Standard crucible
Organic material effusion cell	15-300°C	K	Thermal conduction cooling (TCC) with encapsulated Ta wire heater	Al ₂ O ₃ ; 2, 10, 35 cm ³

HTEZ

Description	T range	TC type	Filament	Standard crucible
High temperature effusion cell	Up to 1900°C	C	W filament	Various Materials; 1.5, 10, 35 cm ³ *

*Crucible material affects maximum temperature

HTEZ-W

Description	T range	TC type	Filament	Standard crucible
High temperature effusion cell	Up to 2000°C	C	Free-standing thick W filament	Various materials; 10 cm ³ *

*Crucible material affects maximum temperature

Available Spares:

- W-heating filament for HTEZ-W

HTS

Description	T range	TC type	Filament	Standard crucible
High temperature source	Up to 2000°C	C	Flat pyrolytic graphite (PG) filament	PG, BeO, PBN, W; wide opening; 5, 25, 200 cm ³

Available Spares:

- Filament set for HTS 40 and HTS 63

HTS-W

Description	T range	TC type	Filament	Standard crucible
High temperature source	Up to 2000°C	C	Free-standing thick W filament	PG, W; 5, 25, 200 cm ³

Available Spares:

- Filament set for HTS-W 40

OREZ

Description	T range	TC type	Filament	Standard crucible
Oxygen resistant effusion cell	200-1200°C	K	Ni alloy (Tmax=1000°C) or noble metal alloy (Tmax=1200°C) wire heating filament (SF, HL, CL, DF)	PBN, Al ₂ O ₃ , BeO, Ir; 10 - 125 cm ³

Available Spares:

- Additional Pt shielding
- Pt alloy filament
- Dual filament for OREZ
- BeO filament rings

SUKO

Description	T range	TC type	Filament	Standard crucible
Carbon sublimating source	Up to 2300°C fil. temp	C	High purity graphite filament (completely shielded with PG parts); Water cooled electrical contacts	

Available Spares:

- Filament set for SUKO 40 and SUKO 63

SUKO-D

Description	T range	TC type	Filament	Standard crucible
p-type doping source for III-V MBE	Up to 2300°C fil. temp	C	High purity graphite filament (completely shielded with PG parts); Water cooled electrical contacts	

Available Spares:

- Filament set for SUKO-D 40

EBV

Horizontally mounted – single pocket. Intended to achieve high growth rates for low vapor pressure materials at high purity

Description	T range	TC type	Filament	Standard crucible
Electron beam evaporator			Short-legged coil of thick W wire, electron emitting filament	PBN; 40, 100 cm ³

Available Spares:

- Evap materials for 100cc: high purity Si and Ge block
- Recharge pill Si and Ge for ERU (for -R refill unit)
- Set of Si shielding parts for 250/200 – 100 (single cover plates available also)
- Si-crucible liner
- W-filament (set of 5)

- Complete Emitter Assembly
- Power Supply 3, 5 and 10 kW

EBVM

Horizontally mounted – 3, 4, 5 or 6 pockets.

Description	T range	TC type	Filament	Standard crucible
Multi-pocket electron beam evaporator			Short-legged coil of thick W wire, electron emitting filament	OFHC copper; 8, 15 cm ³

Available Spares:

- Mounting Frame with slide
- Grounding Tool (for EBV also)
- W-filament (set of 5)
- Complete Emitter Assembly
- Hearth Liner; 8 and 15 cm³ crucibles (Al₂O₃, BeO, Boron Nitride, Mo, W, ...)
- Power Supply 3, 5 and 10 kW

SUSI (-D)

Description	T range	TC type	Filament	Standard crucible
Si Sublimating (Doping) Source	Up to 1400°C	C	High purity monocrystalline Si-filament (highly doped Si on request)+ Si Shielding of Fil; Water cooled electrical contacts	

Available Spares:

- Filament set for SUSI 40 and SUSI 63
- Filament set for SUSI 40 and SUSI 63 (As doped)

DECO

Description	T range	TC type	Filament	Standard crucible
GaP decomposition source	Up to 1500°C	C	Ta wire heating filament	PBN; 10 - 420 cm ³

HABS

Description	T range	TC type	Filament	Standard crucible
Hydrogen atom beam source	Up to 2100°C		Tungsten Filament	PBN, PG, Al ₂ O ₃ ; 2 - 200 cm ³

Available Accessors:

- Mo-Aperture plate
- UHV Leak valve (VAT)
- All metal valve
- Gas purifier H₂ (O₂)

MBE Accessories

Shutter Module for effusion cell

This drive unit for rotary shutter motion provides a soft change between two shutter positions while vibration level is decreased to increase shutter lifetime in UHV.

- Soft acting rotary shutter module (CCW/ CW; fast (0.2)/ slow (1.0))
- Shutter control unit (1, 6, 12 Channel) (not required with Mistral system controller)

BFM – Beam Flux Monitor

In MBE applications, BFMs can be used to measure the flux ratio of atomic or molecular beams from effusion cells to determine growth rates on sample surfaces. Our standard BFM is pin-compatible with ion gauge controllers of the PGC-series from AML.

Available Spares:

- **CA13778-S Filament Kit:** Twin thoriated iridium filaments – needs compatibility check for specific BFM.
- Pressure gauge controller
- 5 m cable
- 10 m cable

QMB – Film Thickness Monitor

With a Quartz Micro-Balance (QMB), the growth of <1 nm films can be measured in situ to calibrate the flux of effusion cells. Mounted to a linear shift, the flux can be measured directly in front of the sample surface as well as at different positions to determine the uniformity of growth. To minimize temperature effects, the QMB is water-cooled. The flux is determined from the change in natural oscillation frequency of a crystal due to a change of its mass.

Available Spares:

- **CA12766-S Spare Oscillator package:** 6MHz Inficon Crystals in AT-cut plano convex design
Diameter: 14 mm (0,550")
10 crystal per package, Minimum Order Quantity = 1 package

Cooling-water distributor

The MBE Systems LAB 10 and EVO are equipped with cooling-water distributors. These provide cooling-water for MBE equipment where needed and allow for measuring the flow of every single effusion cell, evaporator, (...) if a flow meter is included.

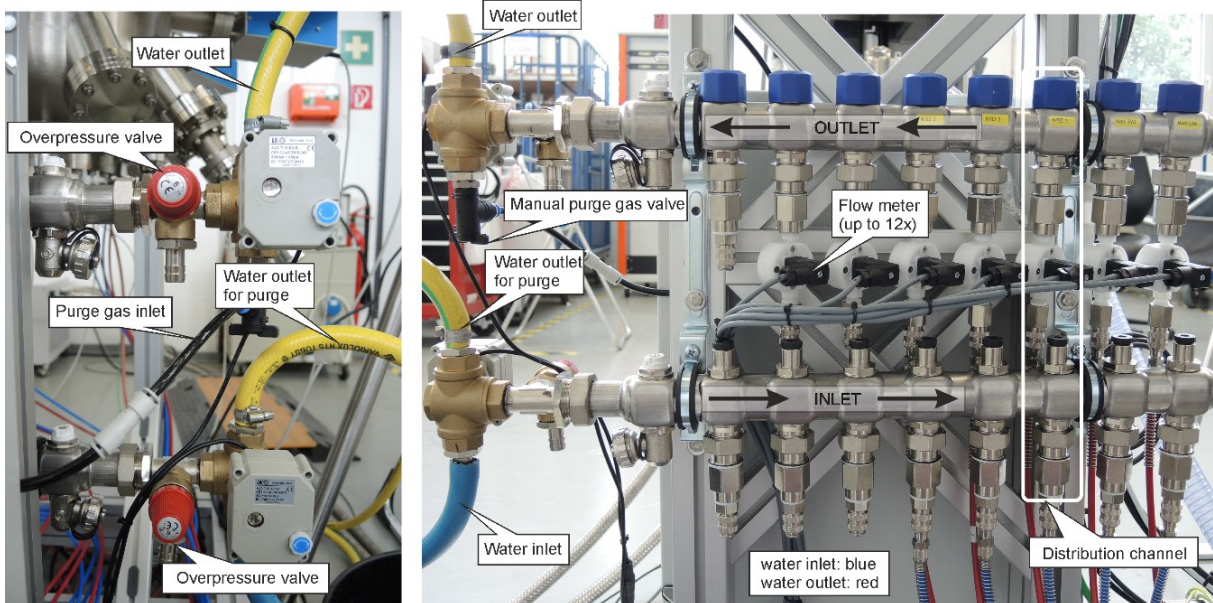

The following spares are available for the 8-fold water distributor **PN06804** (LAB10 Systems) and 12-fold water distributor **PN06805** (EVO Systems).

Additional spares that are not listed here (For example Polyurethane hose for compressed air, Teflon hose for water cooling and corresponding accessories) are available on request.

PN06797 **Coupling socket female**

(NW5) G ¼" (Inner Thread) for distributor, Brass nickel-plated, for use with flow-meter.

PN06798 **Coupling socket male**

(NW5) G ¼" (Outer Thread) for distributor, Brass nickel-plated.

PN05199 **Coupling connector 6 mm**

NW5 connector to distributor, with bend protection for hose, 6 x 4 mm.

Hose Inner Diameter: 4 mm

Hose Outer Diameter: 6 mm

CA11802 **Coupling connector 8 mm**

NW5 connector to distributor, with bend protection for hose, 6 x 8 mm.

Hose Inner Diameter: 6 mm

Hose Outer Diameter: 8 mm

PN06799 **Screw-on fitting female**

G 1/8" for effusion cell, 6 x 4 mm, Brass nickel-plated.

Inner Thread: 1/8"

Hose Inner Diameter: 4 mm

Hose Outer Diameter: 6 mm

Ion sources

ISE 5

Please note: The ISE 5 sputter gun was for its standard application replaced by the IS 40 Ion Source and is no longer produced. Scienta Omicron offers only limited support for this device. The following spare parts are still available:

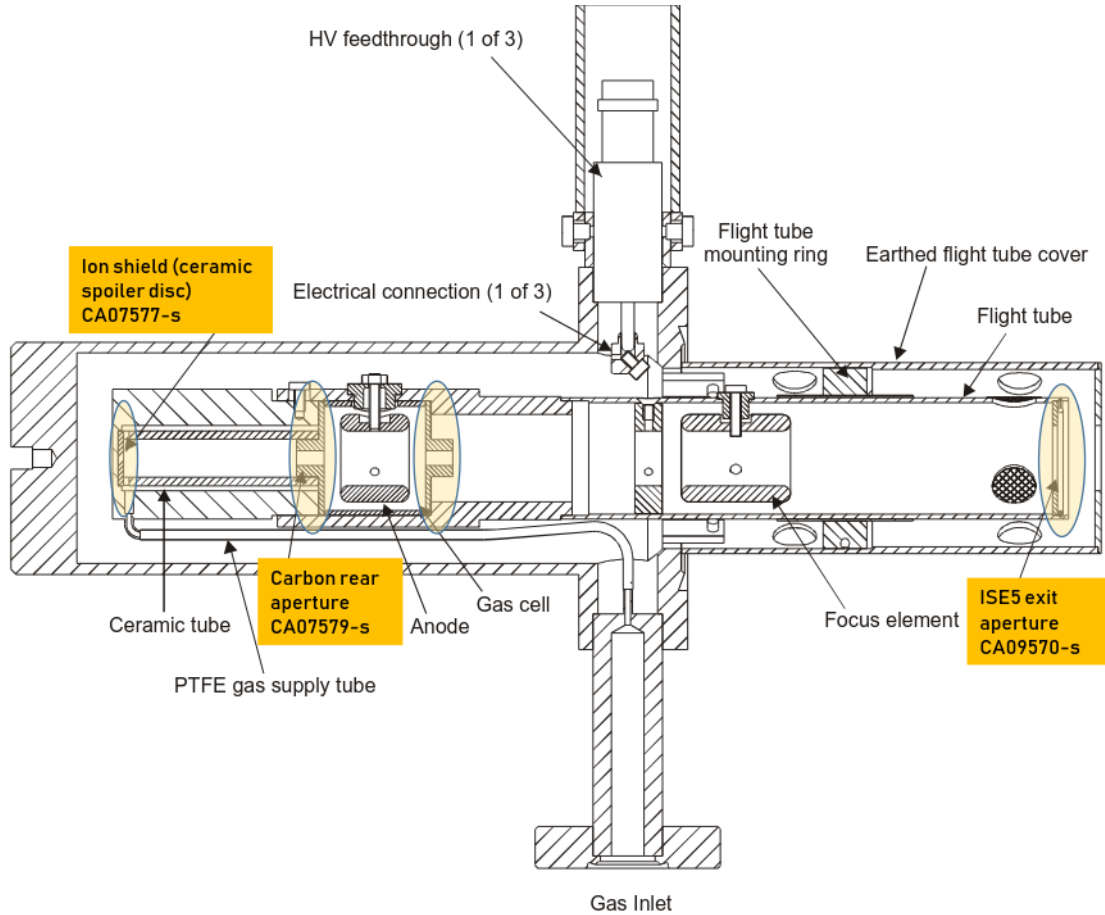

Q00ISE5-S *ISE 5 spares kit*



Q01ISE5-S *ISE 5 ceramics kit*



CA09570-S *ISE 5 exit aperture*

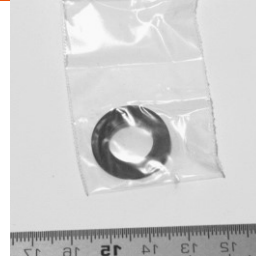

CA07579-S *ISE 5 rear aperture*



CA07577-S *Ion shield (spoiler disk)*



ISE 10 and ISE 100

Please note: The ISE 10 and ISE 100 sputter guns are discontinued. Scienta Omicron offers only limited support for this device. The following spare parts are still available:

D1355-S *Filament for ISE 10 and ISE 100*

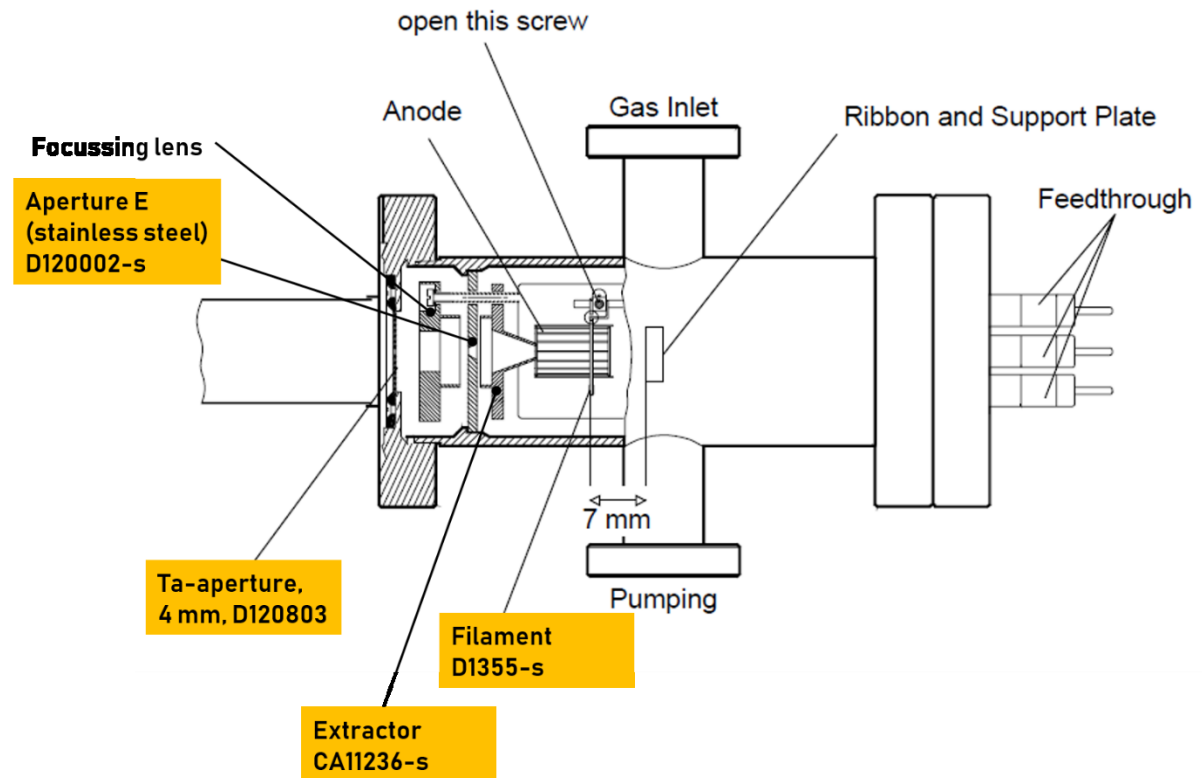

Spare filament for ISE10 and ISE100 sputter sources
The lifetime of the filament is about two years under normal conditions, i.e. electron emission 3 mA using Argon gas.
Using the filament with oxygen reduces the lifetime to about 6 months.



IS 40 Ion Source

QIS4001-S Cathode for Ion sources IS 40C1

QIS4002-S Anode for Ion sources IS 40C1

FIG05

PN02362-S Filament assembly for FIG-05

Spare filament for Fig 05 ion sputter source.

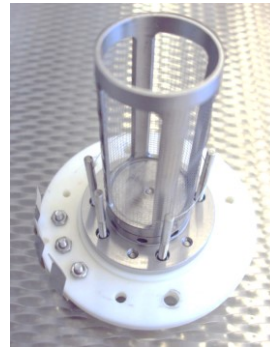

FDG 15 and FDG 150

PN06466-S Spare filament for FDG15/150

The Al gasket is included.

It is important to notice that albeit some settings show a linear behavior of beam current and emission current, the emission limit as specified in the test-sheet (default is 20 mA) should not be exceeded carelessly in order to gain an increase in beam current. High electron emission demands for high filament current, which reduces the filament lifetime significantly.

The default maximum filament current is 1.6 A, which is only reached if

- maximum emission current is increased far beyond its default
- filament coating is damaged or gone

When working within the default parameter range, the filament current should not exceed about 1.4 A.



GCIB

PN06668-S *Filament assembly for GCIB 10s*

If the ion beam power supply shows >10 V and <0.5 A for the filament, then it is likely that the filament is blown. The cold filament should show a resistance of $0.5 - 0.7$ ohms.



IONEC IG70

PN06556-S *Replacement Tungsten filament for IG70 (set of 2 filaments)*

Canion Focused Ion Beam

PN03169-S *Mini Cartridge incl. Gallium Source*

Alternatively, a refilling set for the Gallium source is available.

PN03168-S *Mini Cartridge incl. Gallium Source and cartridge adapter set*

Electron sources and Scanning Electron Microscopes

UHV Gemini

PN04730-S *TFE filament*

Spare thermal field emitter for UHV Gemini, pre-mounted in housing cartridge.

W single crystal with ring of ZrO.

Typical operation temperature: 1800K.

Typical lifetime: 3000 +/- 1000 hours

Typical signs of filament failure: Loss of resolution, unstable extractor current.



Please note: The exchange of the TFE is only possible by qualified service personnel. After mounting and bake-out, the new emitter has to be run up in Service mode and calibration of electron optics needs to be performed, both unavailable in standard user mode. Please request a quote for a respective service visit in addition to the spare part. Typical times required are 2-3 days.

Software

For the SEM application, an upgrade package to Windows 10 PC with SmartSEM 6.0 is available. For the NanoSAM application, the latest upgrade package is to Windows 7 PC and SmartSEM 5.06. The upgrade requires the send-in of the framegrabber card (PN01971). Please note that the framegrabber card can only be exchanged for rev > 3.0. State your current software and hardware version on order.

Vortex

Vortex UHV SEM column

Replacement filament cartridges are available on request.

Channeltron-SED for LT Nanoprobe with Vortex column

PN06688-S *Single channel electron multiplier*

To be mounted on the IN₂ shield of an LT Nanoprobe STM head.

Standard SEM calibration samples

PN01701-S SEM high resolution test sample Au on C

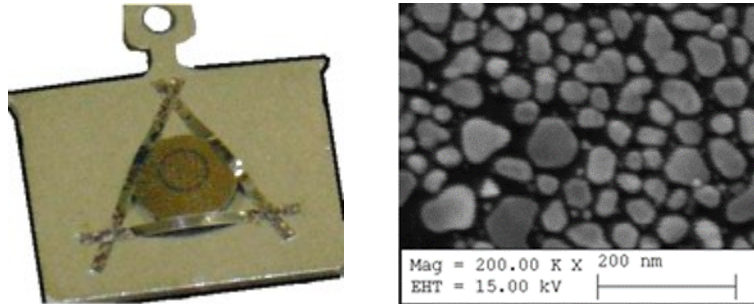

Gold on Carbon, particle size 5 to 150 nm, larger particles in the center of each grid and smaller particles in the edges.

The sample is mounted on top of the sample plate.

For room temperature stages. VT version: **PN01700-S**; LT Nanoprobe version: **PN04755-S**.

PN01704-S SEM calibration test sample

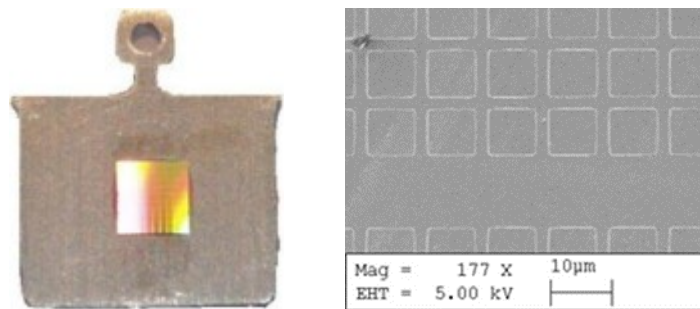

Silicon single crystal 5 mm x 5 mm, squares with a periodicity of 10.00 μm +/- 0.05 μm, width of split-line, appr. 2.0 μm, marker lines with 500 μm distance.

The sample is mounted on top of a standard sample plate. For room temperature stages. VT version: **PN01703-S-S**; LT Nanoprobe version: **PN04756-S**.

PN00061-S Chessy sample plate

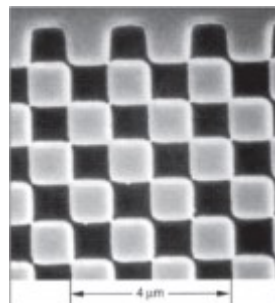

Sample with chessboard structure: gold squares on a silicon substrate. The smallest squares are 1 μm large and create a 10x10 μm chessboard. These chessboards in turn are arranged to form a 100x100 μm chessboard, and these in turn form a 1x1 mm large board. In total 5x5 mm of the sample are filled with squares. The total sample size is around 10x10 mm.

This is only the test sample without sample plate.

Sample Neutralization

FS40A1 Flood Source

QFS4001-S Cathode for flood source FS40A1

CN10 Charge Neutralizer

Please note: The CN10 Charge Neutralizer was for its standard application replaced by the FS 40 Flood Source and is no longer produced. Scienta Omicron offers only limited support for this device. The following spare parts are still available:

Q12MFIL-S CN10 filament module (BaO)

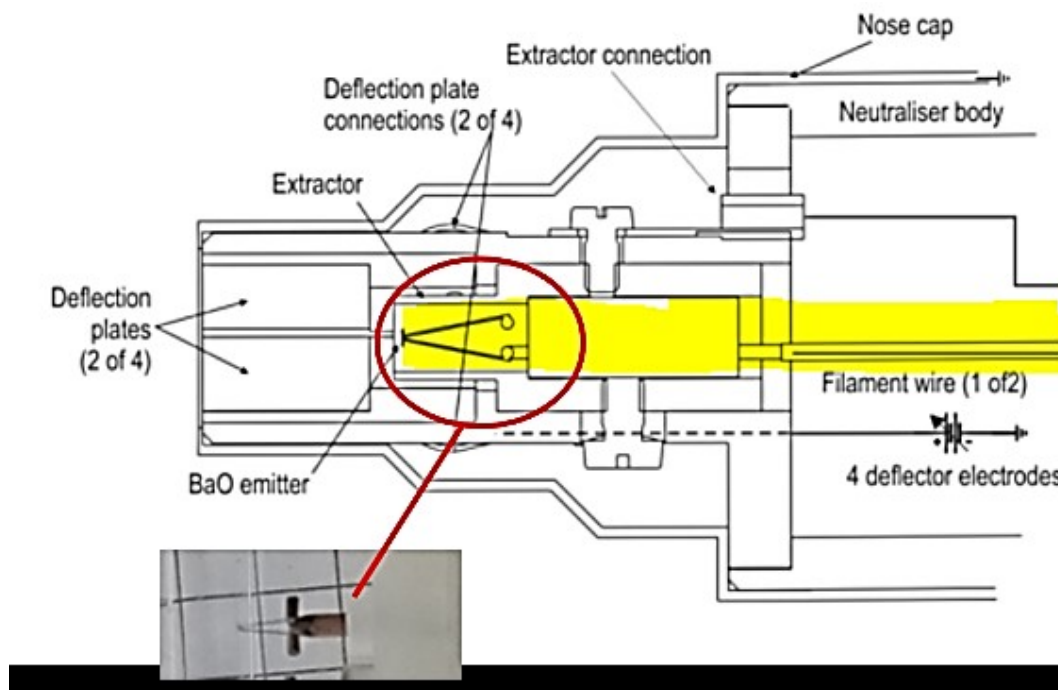

The electron sources for charge neutralization CN10 and CN10+ use a BaO emitter. It can supply a current density up to 400 nA/mm² of electrons. However, it has a limited lifetime if used in vacuum systems that are frequently vented.

The filament assembly consists of a Barium coated substrate that is directly heated by a tungsten hairpin and mounted on a standard base.

The correct procedures must be followed to activate it for maximum emitter lifetime.

UV/Vis Sources

Hg UV Source

D201000-S Replacement light bulb for PEEM HG

The lifetime of the HBO 103 short arc mercury lamp is at least 300 h. The electrodes burn off with advanced life time, resulting in an unstable arc and finally the lamp might not start. The power supply indicates if the lamp is working correctly (green LED).

To replace the HBO lamp, one has to be very cautious since it contains the highly poisonous mercury. For details see the additional OSRAM sheet with directions for use of HBO lamps or visit the OSRAM webpage about sustainability and recycling. All HBO lamps are collected by OSRAM's local recycling partners, which can be found e.g. in the internet.



HIS13/HIS14 VUV Source

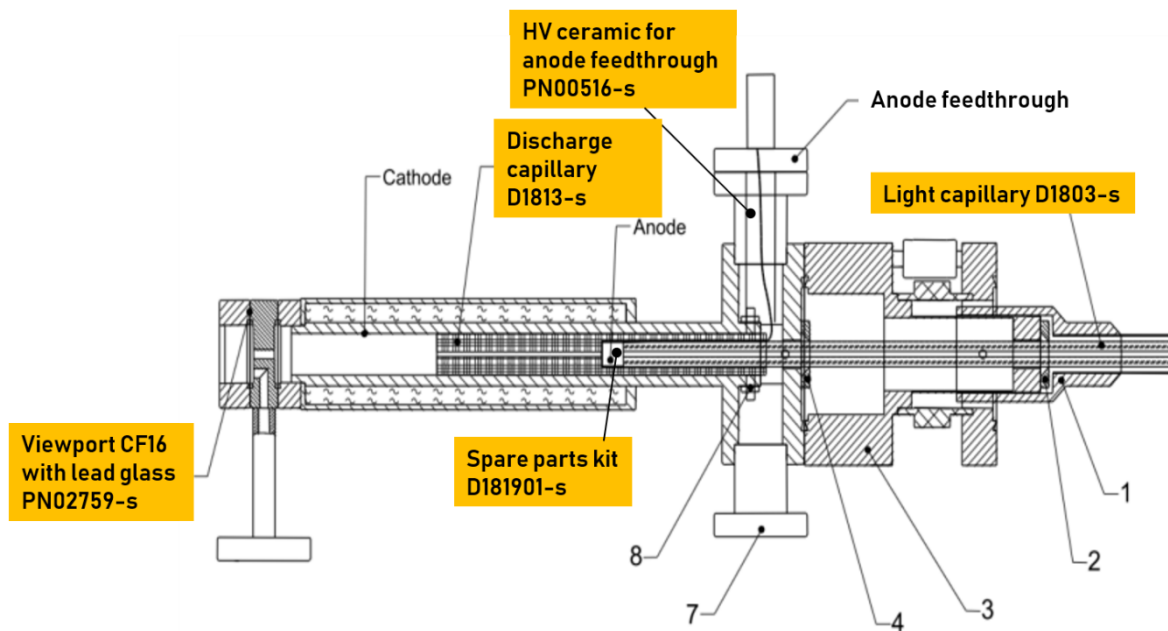

D1803-S Light capillary for HIS13

Please specify serial number, insertion depth and inner diameter of the capillary on order.



D1813-S Discharge capillary for HIS13

After a long operational period of the lamp (typically after several thousands of service hours), especially with frequent use of He II or Ly α with high current, the inside of the discharge capillary will be increasingly metallized because of sputtered cathode material. This



is indicated by a reduced voltage drop during operation and a significantly reduced light yield.

D181901-S Spare parts kit for HIS13

The spare parts kit consists of:

- Anode (Tantal, shown in the picture) with connection cable and plug
- Viton rings
- 1 set of spare screws to fix the flange, the protecting tube and discharge capillary

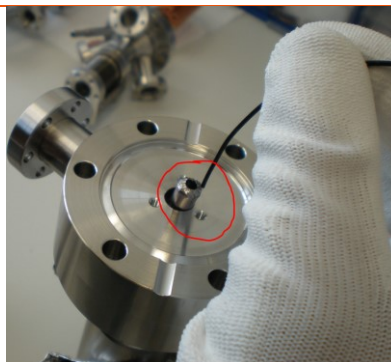

PN00516-S High voltage ceramics

For anode feedthrough of HIS13



PN02759-S Lead glass viewport

CF16 lead glass window for rear viewport of the His13/14



X-Ray sources

HAXPES Metaljet D2+

PN06474-S *A200 cathode assembly for Metaljet D2+*

The useful lifetime of the LaB₆ cathodes used in the MetalJet D2+ systems is expired when the minimum spot size has increased beyond the desired setting or the beam divergence has reduced to the point where the stigmator coils have reached 500 mA.

Life times of a cathodes vary depending on operating parameters. A typical service interval is 2000 h if the source is operated at 250 W with an 80 µm x 20 µm spot size using an A200 cathode. This assumes that the vacuum level of the system is kept in low E-7 mbar range in the "On" state, since elevated vacuum levels accelerate the aging process. Well-conditioned systems typically achieve vacuum levels in the E-8 mbar range in the "Ready" state.



PN06475-S *Jet-pump check valve for Metaljet D2+*

For the jet pump to be able to produce a stable jet pressure, it is vital that the check valves work properly. This means that the balls inside the valves must be able to move freely inside the ball guides to alternately seal tightly against the seat, and easily release from the seat to allow liquid metal to stream past the ball. The picture shows the different parts of the check valve.



One or two check valves should be replaced if the liquid-metal pump cannot maintain correct operating pressure.

PN06476-S *Alloy top off, exalloy-G1 for Metaljet D2+*

Alloy top off may be needed in connection with service of the liquid-metal flow path.

PN06477-S *Jet pump diaphragm kit for Metaljet D2+*

The diaphragm inside the jet-pump head is made of plastics and may be damaged by particles or frozen metal alloy. When this occurs, the diaphragm guard will shut down the jet pump and the diaphragm must be exchanged. The diaphragm consists of two membranes with a synthetic fabric in between that allow sensing membrane failure by measuring the pressure between the two membranes.

This means that hydraulic oil of the jet pump and the liquid metal will not be mixed if one of the membranes fails. Diaphragm failure is detected by the diaphragm guard and is handled by the software.

The manufacturer recommends replacing the diaphragm once a year (together with the lubricant exchange).

PN06478-S Jet pump drive unit oil, 0.5 L, for Metaljet D2+

Manufacturer recommends to

- check the drive unit oil level weekly
- change drive unit oil after 8800 operating hours (1 year) or every 2 years at the latest.

PN06479-S Jet pump hydraulic oil, 2 x 1 L, for Metaljet D2+

Manufacturer recommends to

- check the hydraulic oil level monthly
- change hydraulic oil depending on the degree of soiling, minimum once a year.

PN06480-S Exit window, 10 °, for Metaljet D2+

The exit window consists of a beryllium window and a heated carbon foil. The assembly is designed to protect the beryllium vacuum window from being contaminated by depositions of liquid-metal vapor or droplets. Protection is provided by passing an electrical current through a thin carbon foil, heating the carbon foil to several hundred degrees. Any liquid-metal vapor or droplets ending up on the hot carbon foil is immediately evaporated and the x-ray exit window is kept clean.

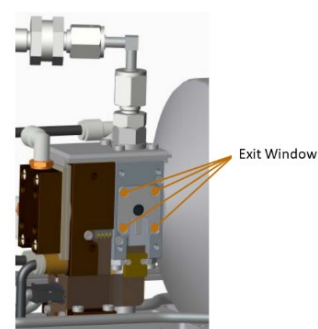

During normal operation of the exit window, the current through the carbon foil is 1.5 A and the applied voltage is about 4 V (± 0.5 V).

The two most common failure modes are

1. Current is 1.5 A, but the voltage is only about 1 V or even lower.
2. Current is about zero and the voltage is significantly higher than 4 V.

Failure mode #1 indicates that the exit window is contaminated by liquid metal in such a way that the carbon foil is not electrically isolated from the steel cover anymore.

Failure mode #2 indicates that the carbon foil is damaged in such a way that the electrical resistance has increased significantly. In both cases the exit window has to be replaced by a new one.

The lifetime of the window has so far been limited by incidents related to jet instabilities or by customer requirements on beryllium window homogeneity.

PN06481-S Nozzle assembly for Metaljet D2+

Nozzles rarely fail during normal operation. However, during jet start and stop there is a small risk that a previously used nozzle fails to produce a stable jet. If there is any indication of an unstable jet in the "Focus" image in the "Results" tab after having reached the "Focus" state, the nozzle assembly should be exchanged for a new one.

PN04682-S Particle filter for Metaljet D2+

The purpose of the particle filter is to trap particles in the liquid metal loop and to allow formation of a stable jet. Replacing the particle filter has a very high probability to produce stable jets again after the introduction of instable jets.

The particle filter should be replaced when the replacement of the nozzle assembly failed to produce a stable jet.



PN06670-S O-ring 20x2, KALREZ (1 PC) for Metaljet D2+

PN06671-S O-ring 110x6, FPM (1 PC) for Metaljet D2+

PN06672-S CF 1.33" gasket, FPM for Metaljet D2+

PN06673-S VCR gasket, SS (5 PCS) for Metaljet D2+

Electron diffraction

SpectraLEED, LEED/Auger, MCPLEED, SPALEED

Please note: The SpectraLEED series is discontinued and was replaced by the IntegraLEED series. Scienta Omicron offers only limited support for this device.

The following compatible replacement filaments are still available:

PN06372-S Spare LaB₆ filament for LEED

Replaces Q02MFIL-S.

PN06391-S Spare thoriated tungsten filament for LEED

Replaces QIRMFIL-S.

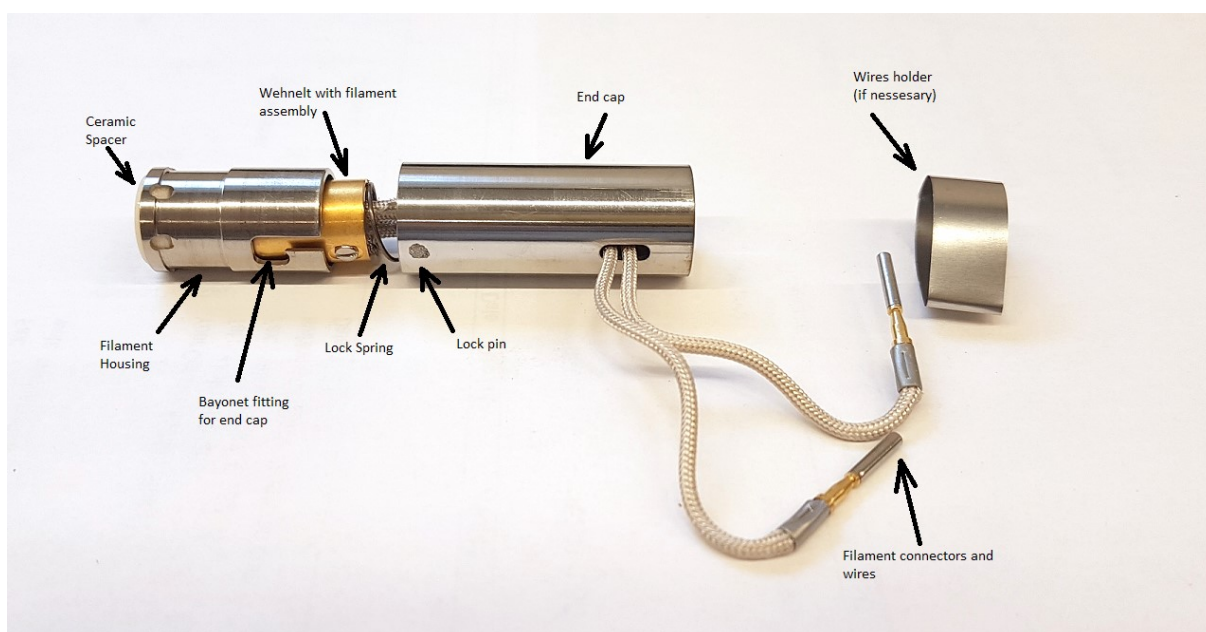

PN06391-S

Please note that those filaments are not compatible to SpectraLEED optics built before September 1989. They are compatible to all standard SpectraLEEDs built after September 1989, although the dimensions are slightly different. The image below shows an old filament housing for reference. The filaments should be formatted in UHV before first use.



QIRMFIL-S

IntegraLEED

PN06828-S *Replacement tungsten hairpin filament for BDL 450/600/800*

PN06829-S *Replacement single crystal LaB6 filament for standard IntegraLEED optics*

2.3 A max, 1.73 A operating current.

Analysers and Detectors

This chapter covers only a very limited selection of the spare parts for analyzers and detectors available from Scienta Omicron. The content will be expanded to cover further instruments in the future. Please contact Scienta Omicron Services for specific spare part inquiries.

PEEM

D203301-S Double multi-channel plate module (for PEEM CP20AD only)

PEEM sample plates



Type A, round, open sample area 5 mm



Type B, round, open sample area 8 mm

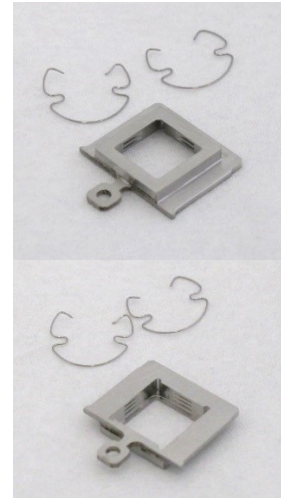

Type C, square, open sample area 9x9 mm

Available materials:

- Mo = Molybdenum
- SS = Stainless steel

PEEM sample plates

Single		Set of 5		Set of 10
D2011-S	Mo, Type A	B002773-S	Mo, Type A	
D201101-S	Mo, Type B	B002774-S	Mo, Type B	
CA10727-S	Mo, Type C	PN06228-S	Mo, Type C	PN06765-S Mo, Type C
D2012-S	SS, Type A	B002775-S	SS, Type A	
D201201-S	SS, Type B	B002776-S	SS, Type B	
CA10726-S	SS, Type C	CA12452-S	SS, Type C	

SPLUED for SEMPA

SPLUED detector for SEMPA in combination with UHV Gemini.

PN03108-S *Spare channeltron for one SEMPA channel*

SPLEED detector spare channeltron pre-mounted in channeltron housing.

It is recommended to replace at least the two channeltrons opposite of each other, preferably all four together to ensure similar performance. Please refer to the technical reference manual of your device for replacement instructions.